



TASK 30

STANDARDS/ GUIDELINES



WAYFINDING SIGNAGE MASTER PLAN

VOLUME 20 CONCOURSES

PROJECT N° FC5801 - C / #7

 **Hartsfield-Jackson**
Atlanta International Airport.

Prepared by:  **AIS** |  **VALANCOURT**
INTERNATIONAL, LLC

1.0

GRAPHIC STANDARDS

VOLUME **20** CONCOURSES

- 11 Typography
- 12 Terminology/Symbology
- 13 Message Hierarchy
- 14 Foreign Language
- 15 Arrow Standards
- 16 Color Standards



1.0 GRAPHIC STANDARDS

- 1.1 Typography 1-01
 - Line Spacing 1-02
- 1.2 Terminology / Symbology
 - Principal Facilities 1-03
 - Fundamental Functions 1-04
 - Building Circulation / Services 1-05
 - Dynamic Message Terminology..... 1-06
 - Specialty Icons - Primary Identification 1-07
- 1.3 Message Hierarchy
 - Message Function 1-08
 - Message Hierarchy Examples 1-09
- 1.4 Foreign Language
 - Foreign Language 1-10
 - Multi Lingual Text Translations 1-11
 - Multi Lingual Text Translations Cont'd 1-12
- 1.5 Arrow Standards 1-13
- 1.6 Color Standards
 - Color Specifications 1-14
 - Color Application – Primary Directional – Overhead 1-15

#	REVISION	DATE
1	Updated	05/06/16
2	Updated	08/24/17

ABCDEFGHIJKLMNOPQRSTUVWXYZ
 abcdefghijklmnopqrstuvwxyz
 0123456789@#%^&*()::

Gotham Book



Letter Spacing Correct - Kerning at "- 33 points"



Letter Spacing Too Wide



Letter Spacing Too Close

#	REVISION	DATE
1	Updated	05/06/16
2	Updated	08/24/17

Line Spacing

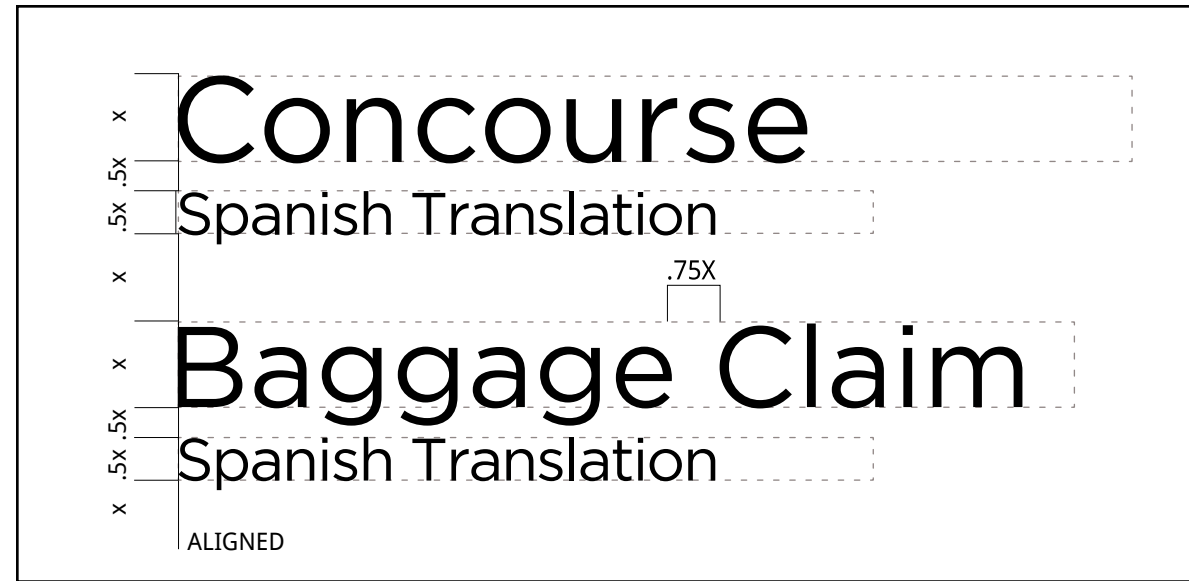

Line Spacing Examples

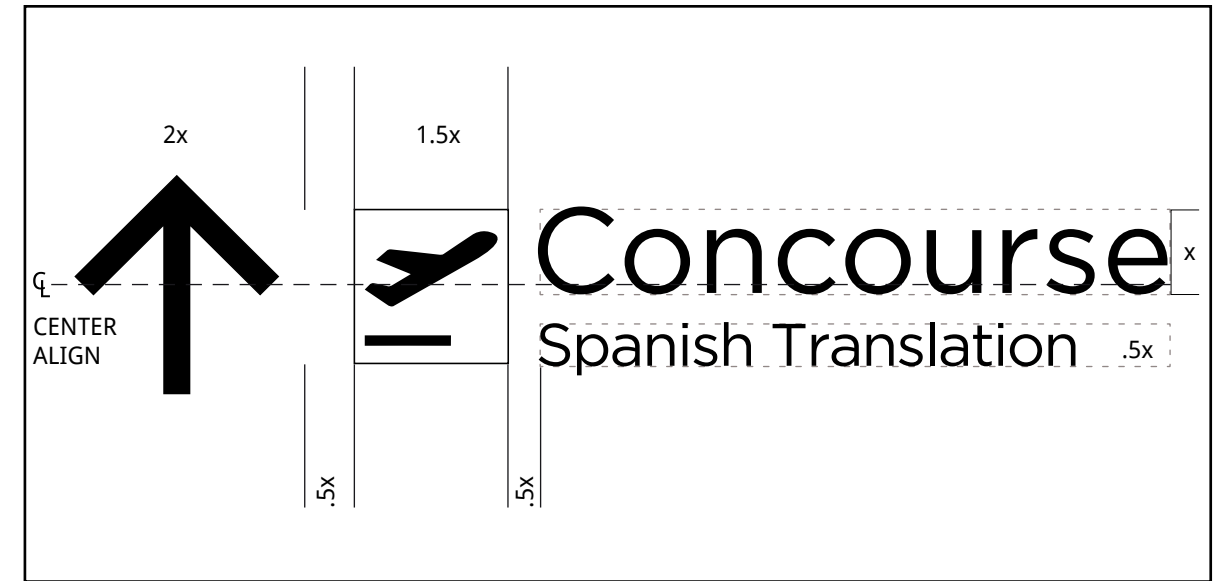

Spacing Example between arrow, symbol and messages

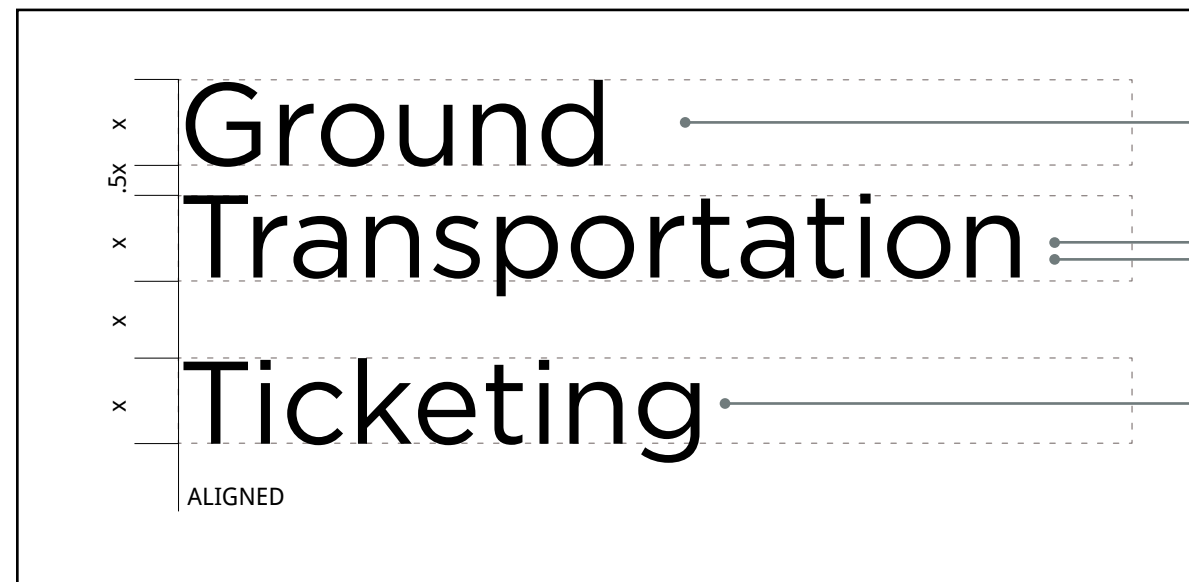

Unrelated Line Spacing Examples

RELATED LINES OF TEXT

UNRELATED LINES OF TEXT

Principal Facilities

#	REVISION	DATE
1	Updated	05/06/16
2	Updated	08/24/17

TERMINOLOGY

SYMBOL

INTERIOR APPLICATIONS

Domestic Terminal



- Identifies Domestic Terminal
- Primary information

International Terminal



- Identifies International Terminal
- Primary information

Concourse T



- Identifies a Concourse
- Primary information

Concourse A



- Identifies a Concourse
- Primary information

Concourse B



- Identifies a Concourse
- Primary information

Concourse C



- Identifies a Concourse
- Primary information

Concourse D



- Identifies a Concourse
- Primary information

Concourse E



- Identifies a Concourse
- Primary information

Concourse F



- Identifies a Concourse
- Primary information

Gates



- Identifies a Gate
- Primary information

Fundamental Functions

#	REVISION	DATE
1	Updated	05/06/16
2	Updated	08/24/17

TERMINOLOGY

SYMBOL

INTERIOR APPLICATIONS

Domestic Baggage Claim



· Identifies Domestic Baggage Claim

International Baggage Claim



· Identifies International Baggage Claim

Ground Transportation



· Identifies Ground Transportation



#	REVISION	DATE
1	Updated	05/06/16
2	Updated	08/24/17

Building Circulation

TERMINOLOGY

SYMBOL

INTERIOR APPLICATIONS

Elevators

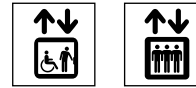

· Identifies elevators

Escalators



· Identifies escalators

Stairs



· Identifies stairs

Emergency Stairs



· Identifies emergency stairs

Services

TERMINOLOGY

SYMBOL

INTERIOR APPLICATIONS

Restrooms (Men, Women, Family)



· Identifies restrooms facilities

Information



· Identifies service that provides information



Dynamic Message Terminology

#	REVISION	DATE
1	Updated	05/06/16
2	Updated	08/24/17

TERMINOLOGY

Domestic Terminal

International Terminal

Domestic Baggage Claim

International Baggage Claim

Ground Transportation

Train to :

Walk to :

Note:
Dynamic messages shown are samples only.
Owner will review / confirm all messages.

Specialty Icons - Primary Identification

#	REVISION	DATE
1	Updated	05/06/16
2	Updated	08/24/17

TERMINOLOGY

SYMBOL

INTERIOR APPLICATIONS

Concourse T



· Identifies Concourse T

Concourse A



· Identifies Concourse A

Concourse B



· Identifies Concourse B

Concourse C



· Identifies Concourse C

Concourse D



· Identifies Concourse D

Concourse E



· Identifies Concourse E

Concourse F



· Identifies Concourse F



#	REVISION	DATE
1	Updated	05/06/16
2	Updated	08/24/17

Message Function

	PRIMARY	SECONDARY	TERTIARY
Directional	Domestic Terminal International Terminal Concourses T, A, B, C, D, E, F	Gates International Baggage Claim Domestic Baggage Claim Ground Transportation Restrooms	Train to:
Identification	Concourse T Concourse A Concourse B Concourse C Concourse D Concourse E Concourse F Gate numbers (Over doorway)	Restrooms (Men/Women/Family) Elevators Information <i>(Airline Names)</i> <i>(Concessions/Retailers)</i>	<i>(Room/Door I.D.)</i>
Information or Orientation	<i>(Airport Directory)</i> <i>(MUFIDS)</i>	<i>(Visual Paging)</i> <i>(Supplemental Languages)</i>	
Regulatory or Safety	Exit Emergency Exit Only No Smoking Authorized Personal Only Do Not Enter Be Careful. Watch Your Step. <i>(All FAA notices and required signs)</i>		

1.0 GRAPHIC STANDARDS

#	REVISION	DATE
1	Updated	05/06/16
2	Updated	08/24/17

1.3 Message Hierarchy

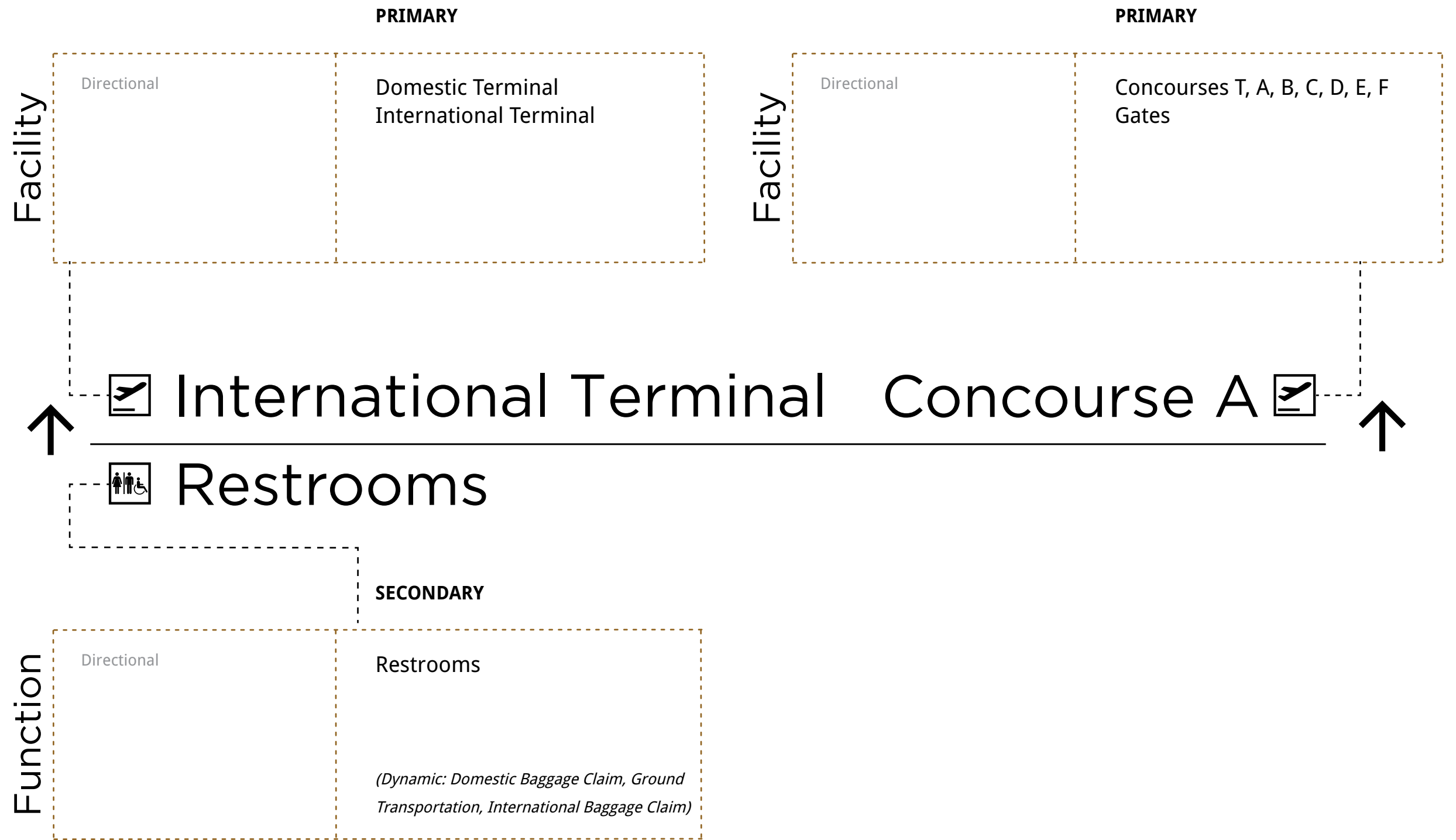

Notes:
 Directional Primary Message Hierarchy Example
 1. Correct Terminology:
 a. Terminal North
 b. Terminal South
 c. Domestic Terminal
 d. International Terminal
 2. Incorrect Terminology: Domestic Terminal North
 SCALE: NTS

#	REVISION	DATE
1	Updated	05/06/16
2	Updated	08/24/17

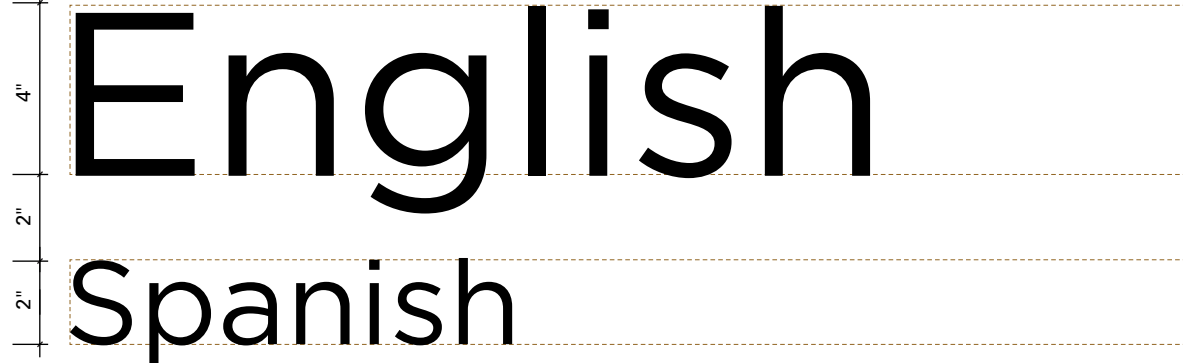

Primary Foreign Language Translation Application
Overhead Directional Signs
SCALE: NTS

Multi-Lingual Text Translation

Principal Airport Facilities

ENGLISH	TRANSLATION
Domestic Terminal	Terminales
International Terminal	Terminal Internacional
Concourses T, A, B, C, D, E, F	Terminales T, A, B, C, D, E, F
Gates	Puertas de Embarque

Fundamental Airport Functions

ENGLISH	TRANSLATION
Domestic Baggage Claim	Reclamo de Equipaje Nacional
International Baggage Claim	Reclamo de Equipaje Internacional
Ground Transportation	Transporte Terrestre

Note:
Final messages will be reviewed / approved by Department of Aviation

Multi-Lingual Text Translation cont'd.

#	REVISION	DATE
1	Updated	05/06/16
2	Updated	08/24/17

Building Circulation

Services

ENGLISH

TRANSLATION

ENGLISH

TRANSLATION

Elevators

Ascensor

Restrooms (Men, Women, Family)

Baños (Caballeros, Damas, Familiar)

Escalators

Escalera Eléctrica

Information

Información

Stairs

Escalera

Emergency Stairs

Escalera de Emergencia

Elevator to:

Ascensor a:

Train to:

Tren a:

*Note:
Final messages will be reviewed / approved by Department of Aviation*

1.0 GRAPHIC STANDARDS

#	REVISION	DATE
1	Updated	05/06/16
2	Updated	08/24/17

1.5 Arrow Standards

These figures define the arrow orientations and size that shall be used throughout the Concourses

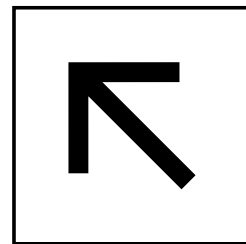

Up to the Left
10 o'clock

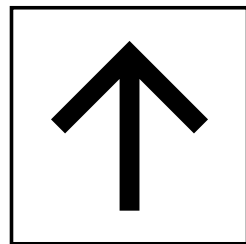

Up and/or Straight
Ahead / 12 o'clock

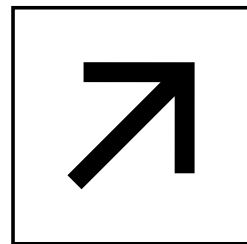

Up to the Right
2 o'clock

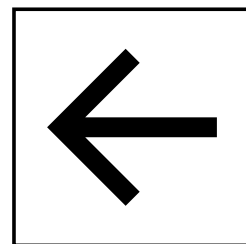

To the left
9 o'clock

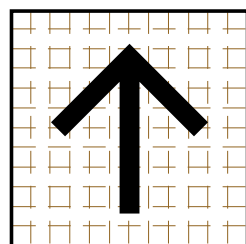

Up and/or Straight
Ahead / 12 o'clock

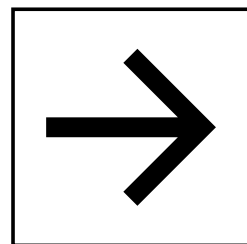

To the Right
3 o'clock

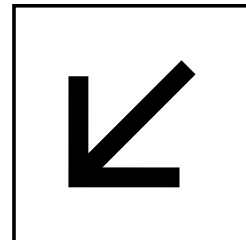

Down to the Left
7 o'clock

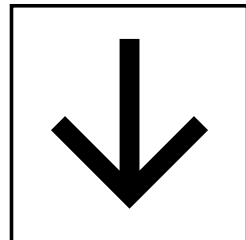

Down
6 o'clock

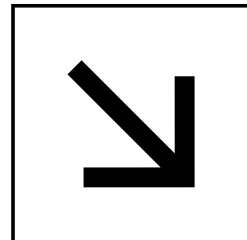

Down to the Right
5 o'clock

Arrows Orientation
SCALE: NTS

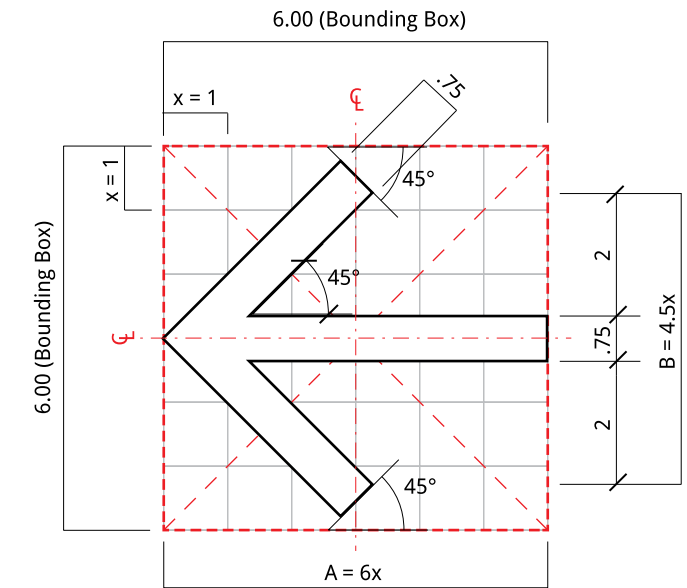

Straight Arrow:
Use for arrows angled at: 0°, 90°, 180°, 270°

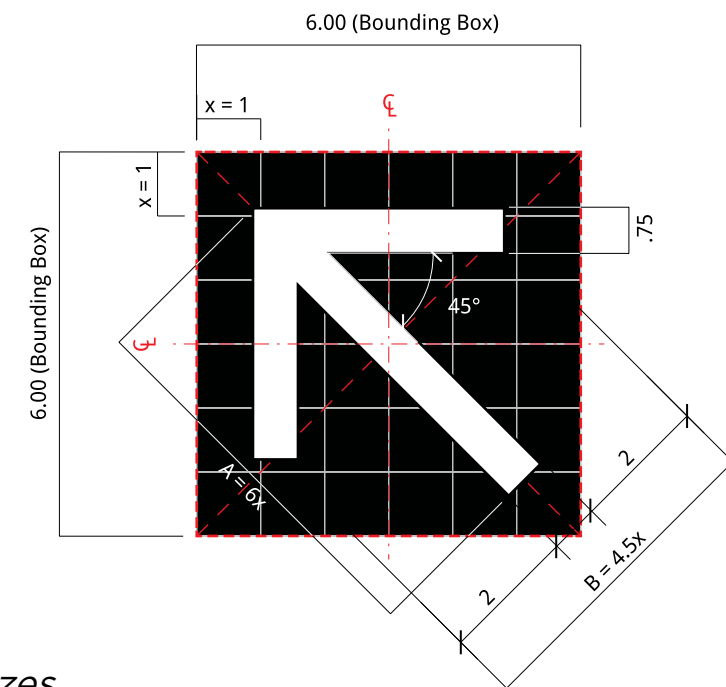

Angled Arrow:
Use for arrows angled at: 45°, 135°, 225°, 315°





Arrows Sizes
SCALE: NTS

Color Specifications

#	REVISION	DATE
1	Updated	05/06/16
2	Updated	08/24/17

This section of the document shall specify colors and applications that are to be used in the Concourses.

**or approved equal*

COLOR APPLICATION	COLOR	PANTONE Equivalent	MATERIAL Equivalent
Concourse Identifications	N/A	N/A	 Satin Brushed Aluminum
Sign Panel	N/A	N/A	 Satin Brushed Aluminum
Accent Panel			
- Concourse T	White	N/A	Sign Grade Transluscent Polycarbonate
- Concourse A	White	N/A	Sign Grade Transluscent Polycarbonate
- Concourse B	White	N/A	Sign Grade Transluscent Polycarbonate
- Concourse C	White	N/A	Sign Grade Transluscent Polycarbonate
- Concourse D	White	N/A	Sign Grade Transluscent Polycarbonate
- Concourse E	Yellow	 Pantone 123	Sign Grade Transluscent Polycarbonate
- Concourse F	Yellow	 Pantone 123	Sign Grade Transluscent Polycarbonate
Arrow	White	N/A	Sign Grade Transluscent Polycarbonate
Symbol	White	N/A	Sign Grade Transluscent Polycarbonate
Background	Black	 Process Black	Sign Grade Transluscent Polycarbonate
English Text	White	N/A	Sign Grade Transluscent Polycarbonate
Translation Text	White	N/A	Sign Grade Transluscent Polycarbonate

Note: Color palette should not be substituted / replaced.

Color Applications - Primary Directional - Overhead

#	REVISION	DATE
1	Updated	05/06/16
2	Updated	08/24/17

Sign Finishes

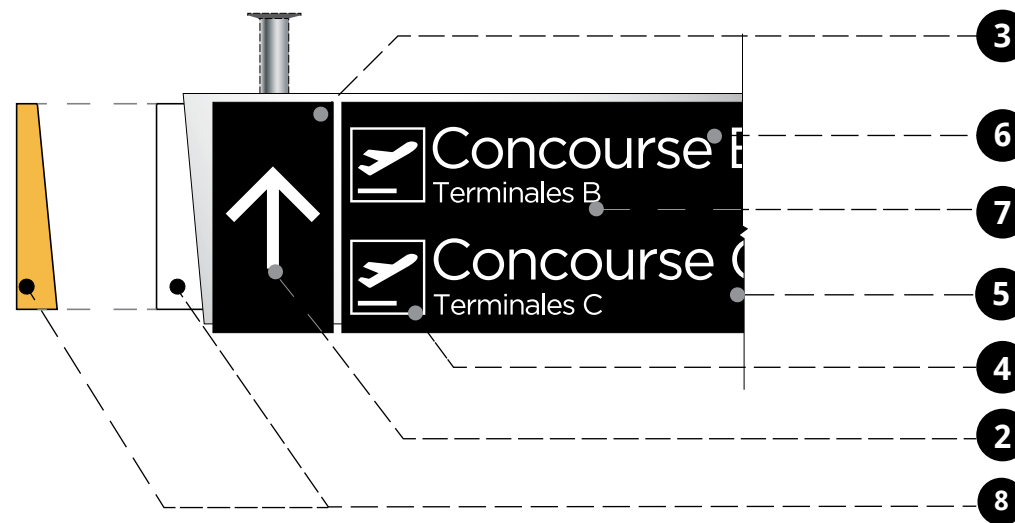
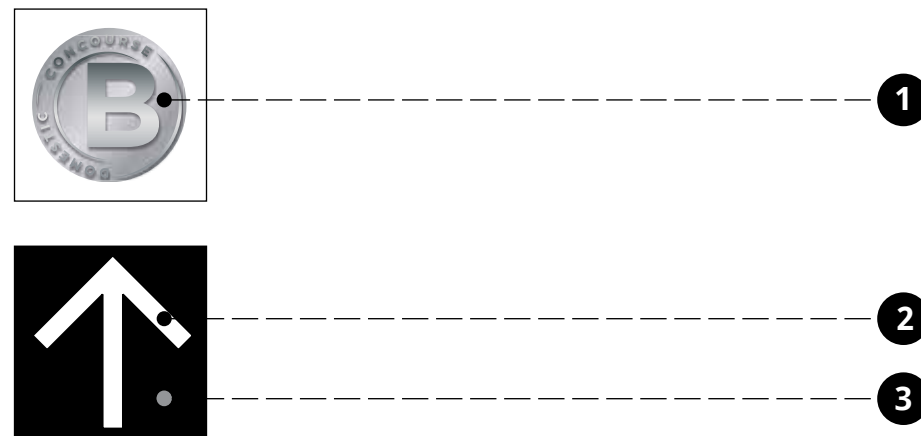

Sign Color Application

COLOR APPLICATION	COLOR
1 Concourse Identification - Concourse T - Concourse A - Concourse B - Concourse C - Concourse D - Concourse E - Concourse F	Dimensional letters on Satin Brushed Aluminum Background
2 Arrow	White
3 Arrow Panel	Process Black
4 Symbol	White
5 Background	Process Black
6 English Text	White
7 Translation Text	White
8 Accent Bar	White (Domestic) / Pantone 123 (International)

Color Application Examples
 SCALE: NTS
 Note: Color palette should not be substituted / replaced.

2.0

SIGN TYPES CONCOURSES

VOLUME **20** CONCOURSES

- 2.1 Sign Type Series Number
- 2.2 Sign Type Identification System
- 2.3 Sign Type Index
- 2.4 Sign Type Layouts

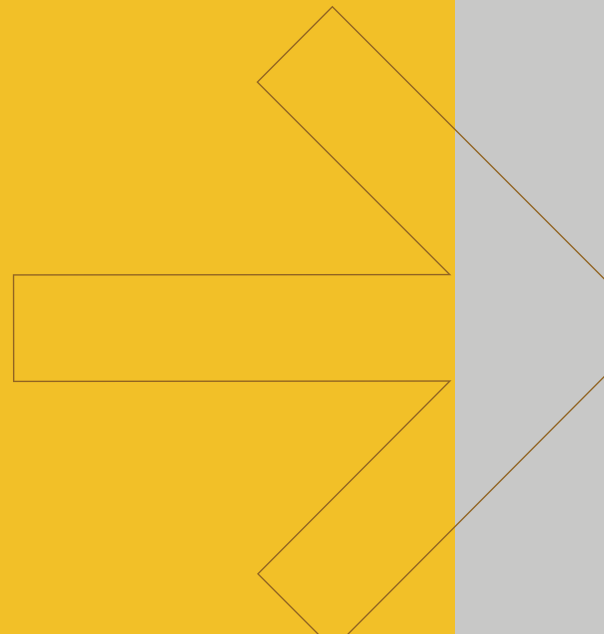

2.0 SIGN TYPES

2.1 Sign Type Series Number 2-01

2.2 Sign Type Identification System 2-02

2.3 Sign Type Index 2-03

2.4 Sign Type Layouts

 ST-200 - Primary Directional - Ceiling Suspended 2-07

 ST-202 - Primary Directional - Ceiling Suspended (Dynamic) 2-08

 ST-204 - Primary Directional - Soffit Mounted 2-09

 ST-206 - Primary Directional - Soffit Mounted (Dynamic) 2-10

 ST-212 - Primary Directional - Soffit Mounted 2-11

 ST-222 - Secondary Directional - Soffit Mounted (Dynamic) 2-12

 ST-224 - Secondary Directional - Soffit Mounted 2-13

 ST-228 - Secondary Directional - Soffit Mounted 2-14

 ST-240 - Primary Identification - Ceiling Suspended 2-15

 ST-250 - Secondary Identification - Flag Mounted 2-16

 ST-252 - Secondary Identification - Wall Mounted 2-17

 ST-254 - Secondary Identification - Wall Mounted 2-18

 ST-256 - Secondary Identification - Wall Mounted 2-19

 ST-258 - Secondary Identification - Wall Mounted 2-20

 ST-260 - Primary Informational - Wall Mounted 2-21

2.0 SIGN TYPE CONCOURSES

#	REVISION	DATE
1	Updated	05/06/16
2	Updated	08/24/17

2.1 Sign Type Series Number

- **100 Series** – Terminals (Domestic / International)
 - 100 - 129 – Primary Directional
 - 130 - 139 – Secondary Directional
 - 140 - 149 – Primary Identification
 - 150 - 159 – Secondary Identification
 - 160 - 169 – Primary Informational
 - 170 - 179 – Secondary Informational

- **200 Series** – Concourses
 - 200 - 219 – Primary Directional
 - 220 - 239 – Secondary Directional
 - 240 - 249 – Primary Identification
 - 250 - 259 – Secondary Identification
 - 260 - 269 – Primary Informational
 - 270 - 279 – Secondary Informational

- **300 Series** – Transportation Malls
 - 300 - 329 – Primary Directional
 - 330 - 339 – Secondary Directional
 - 340 - 349 – Primary Identification
 - 350 - 359 – Secondary Identification
 - 360 - 369 – Primary Informational
 - 370 - 379 – Secondary Informational

- **400 Series** – Ground Transportation (Domestic / International)
 - 400 - 429 – Primary Directional
 - 430 - 439 – Secondary Directional
 - 440 - 449 – Primary Identification
 - 450 - 459 – Secondary Identification
 - 460 - 469 – Primary Informational
 - 470 - 479 – Secondary Informational

- **500 Series** – Curbsides (Domestic / International)
 - 500 - 529 – Primary Directional
 - 530 - 539 – Secondary Directional
 - 540 - 549 – Primary Identification
 - 550 - 559 – Secondary Identification
 - 560 - 569 – Primary Informational
 - 570 - 579 – Secondary Informational

- **600 Series** – Parking (Domestic / International)
 - 600 - 629 – Primary Directional
 - 630 - 639 – Secondary Directional
 - 640 - 649 – Primary Identification
 - 650 - 659 – Secondary Identification
 - 660 - 669 – Primary Informational
 - 670 - 679 – Secondary Informational

- **700 Series** – Roadways (Domestic / International)
 - 700 - 729 – Primary Directional
 - 730 - 739 – Secondary Directional
 - 740 - 749 – Primary Identification
 - 750 - 759 – Secondary Identification
 - 760 - 769 – Primary Informational
 - 770 - 779 – Secondary Informational

Project:



HARTSFIELD-JACKSON ATLANTA INTERNATIONAL AIRPORT
Wayfinding Signage Masterplan

Document Title:

Task 3.0 - STANDARDS / GUIDELINES
Project No.: FC5801 - C / #7

Issued as: **Final** Date: **August 2017**

REV. 05/06/16
REV. 08/24/17
REV.

Prepared by:



**VOLUME 2.0
CONCOURSES**
2.1 Sign Type Series Number

PAGE

2-01

Sign Location Indicator

#	REVISION	DATE
1	Updated	05/06/16
2	Updated	08/24/17

2.2-1 Sign Location Indicator

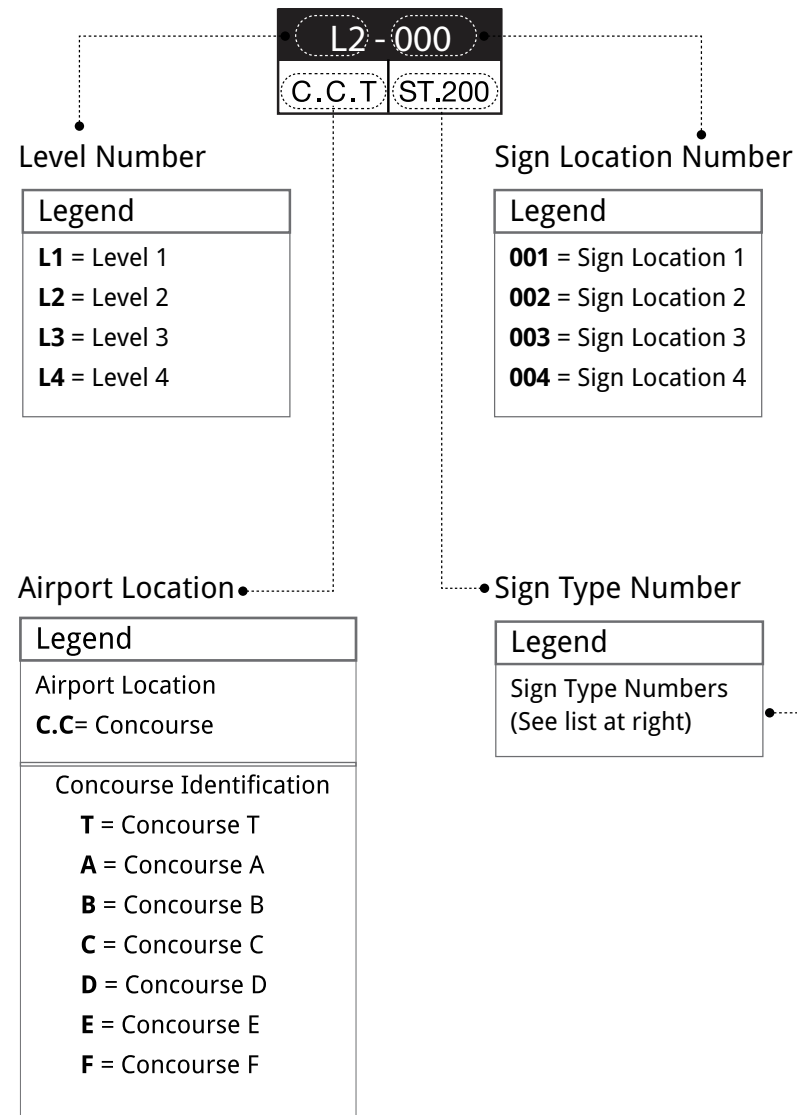

2.2-2 Sign Type Series Numbers - Concourses

Sign Type 200 Series – Concourses
ST. 200 - ST. 219 – Primary Directional
ST. 220 - ST. 239 – Secondary Directional
ST. 240 - ST. 249 – Primary Identification
ST. 250 - ST. 259 – Secondary Identification
ST. 260 - ST. 269 – Primary Informational
ST. 270 - ST. 279 – Secondary Informational

2.0 SIGN TYPE CONCOURSES

#	REVISION	DATE
1	Updated	05/06/16
2	Updated	08/24/17

2.3 Sign Type Index

ST-200 Primary Directional - Ceiling Suspended		
Domestic Concourses	International Concourses	N/A
		N/A
<ul style="list-style-type: none"> - 2 Directionals / 2 Levels of Messaging / 2 Sided - Overall dimensions: 2'- 0" H x 15' - 5" W x 7" D - Provides primary directional information - For use in Domestic Concourses only: Accent Color White 	<ul style="list-style-type: none"> - 2 Directionals / 2 Levels of Messaging / 2 Sided - Overall dimensions: 2'- 0" H x 15' - 5" W x 7" D - Provides primary directional information - For use in International Concourses only : Accent Color Yellow - Pantone 123 	N/A
ST-202 Primary Directional - Ceiling Suspended (Dynamic)		
Domestic Concourses	International Concourses	N/A
		N/A
<ul style="list-style-type: none"> - 2 Directionals / 2 Levels of Messaging / 2 Sided with Dynamic Display - Overall dimensions: 2'- 4" H x 15' - 5" W x 7" D - Provides directional information in multi directional areas and key decisionpoints - For use in Domestic Concourses only: Accent Color White 	<ul style="list-style-type: none"> - 2 Directionals / 2 Levels of Messaging / 2 Sided with Dynamic Display Bar - Overall dimensions: 2'- 4" H x 15' - 5" W x 7" D - Provides directional information in multi directional areas and key decisionpoints - For use in International Concourses only : Accent Color Yellow - Pantone 123 	N/A
ST-204 Primary Directional - Soffit Mounted		
Domestic Concourses	International Concourses	N/A
		N/A
<ul style="list-style-type: none"> - 2 Directionals / 2 Levels of Messaging / 1 Sided - Overall dimensions: 2'- 0" H x 15' - 4" W x 5" D - Provides primary directional information - For use in Domestic Concourses only: Accent Color White 	<ul style="list-style-type: none"> - 2 Directionals / 2 Levels of Messaging / 1 Sided - Overall dimensions: 2'- 0" H x 15' - 4" W x 5" D - Provides primary directional information - For use in International Concourses only : Accent Color Yellow - Pantone 123 	N/A
ST-206 Primary Directional - Wall Mounted (Dynamic)		
Domestic Concourses	International Concourses	N/A
		N/A
<ul style="list-style-type: none"> - 2 Directionals / 2 Levels of Messaging / 1 Sided with Dynamic Display - Overall dimensions: 2'- 4" H x 15' - 4" W x 5" D - Provides directional information in multi directional areas - For use in Domestic Concourses only: Accent Color White 	<ul style="list-style-type: none"> - 2 Directionals / 2 Levels of Messaging / 1 Sided with Dynamic Display - Overall dimensions: 2'- 4" H x 15' - 4" W x 5" D - Provides directional information in multi directional areas - For use in International Concourses only : Accent Color Yellow - Pantone 123 	N/A

Project:



HARTSFIELD-JACKSON ATLANTA INTERNATIONAL AIRPORT
Wayfinding Signage Masterplan

Document Title:

Task 3.0 - STANDARDS / GUIDELINES
Project No.: FC5801 - C / #7

Issued as: **Final**

Date: **August 2017**

REV. 05/06/16
REV. 08/24/17
REV.

REV.
REV.
REV.

Prepared by:



VOLUME 2.0
CONCOURSES
2.3 Sign Type Index

PAGE

2-03

2.0 SIGN TYPE CONCOURSES

#	REVISION	DATE
1	Updated	05/06/16
2	Updated	08/24/17







2.3 Sign Type Index

ST-212 Primary Directional - Soffit Mounted		
Domestic Concourses	International Concourses	N/A
<ul style="list-style-type: none"> - 2 Directionals / 1 Level of Messaging / 1 Side - Overall dimensions: 1'- 1 1/2" H x 15' - 4" W x 5" D - Provides primary directional information - For use in Domestic Concourses only: Accent Color White 	<ul style="list-style-type: none"> - 2 Directionals / 1 Level of Messaging / 1 Side - Overall dimensions: 1'- 1 1/2" H x 15' - 4" W x 5" D - Provides primary directional information - For use in International Concourses only : Accent Color Yellow - Pantone 123 	N/A
ST-222 Secondary Directional - Soffit Mounted (Dynamic)		
Domestic Concourses	International Concourses	N/A
<ul style="list-style-type: none"> - 1 Directional / 2 Levels of Messaging / 1 Sided with <u>Dynamic Display</u> - Overall dimensions: 2'- 4" H x 7' - 10" W x 5" D - Provides secondary directional information - For use in Domestic Concourses only: Accent Color White 	<ul style="list-style-type: none"> - 1 Directional / 2 Levels of Messaging / 1 Sided with <u>Dynamic Display</u> - Overall dimensions: 2'- 4" H x 7' - 10" W x 5" D - Provides secondary directional information - For use in International Concourses only : Accent Color Yellow - Pantone 123 	N/A
ST-224 Secondary Directional - Ceiling Suspended		
Domestic Concourses	International Concourses	N/A
<ul style="list-style-type: none"> - 1 Directional / 1 Level of Messaging / 2 Sided - Overall dimensions: 1'- 1-1/2" H x 7' - 10" W x 7" D - Provides secondary directional information - For use in Domestic Concourses only: Accent Color White 	<ul style="list-style-type: none"> - 1 Directional / 1 Level of Messaging / 2 Sided - Overall dimensions: 1'- 1-1/2" H x 7' - 10" W x 7" D - Provides secondary directional information - For use in International Concourses only : Accent Color Yellow - Pantone 123 	N/A
ST-228 Secondary Directional - Soffit Mounted		
Domestic Concourses	International Concourses	N/A
<ul style="list-style-type: none"> - 1 Directional / 1 Level of Messaging / 1 Sided - Overall dimensions: 1'- 1-1/2" H x 7' - 10" W x 5" D - Provides secondary directional information - For use in Domestic Concourses only: Accent Color White 	<ul style="list-style-type: none"> - 1 Directional / 1 Level of Messaging / 1 Sided - Overall dimensions: 1'- 1-1/2" H x 7' - 10" W x 5" D - Provides secondary directional information - For use in International Concourses only : Accent Color Yellow - Pantone 123 	N/A

2.0 SIGN TYPE CONCOURSES

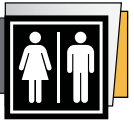
#	REVISION	DATE
1	Updated	05/06/16
2	Updated	08/24/17







2.3 Sign Type Index

ST-240 Primary Identification - Ceiling Suspended		
Domestic Concourses	International Concourses	N/A
		
<ul style="list-style-type: none"> - 2 Sided with Dynamic Display Panel - Overall dimensions: 2'- 9-1/2" H x 3' - 4-7/8" W x 11.6" D - Provides Flight information - For use in Domestic Concourses only: Accent Color White 	<ul style="list-style-type: none"> - 2 Sided with Dynamic Display Panel - Overall dimensions: 2'- 9-1/2" H x 3' - 4-7/8" W x 11.6" D - Provides Flight information - For use in International Concourses only : Accent Color Yellow - Pantone 123 	N/A
ST-250 Secondary Identification - Flag Mounted		
Domestic Concourses	International Concourses	N/A
		
<ul style="list-style-type: none"> - Overall dimensions: 1'- 1-1/2" H x 1' - 4" W x 5" D - 2 Sided - Provides Restrooms / Elevator information - For use in Domestic Concourses only: Accent Color White 	<ul style="list-style-type: none"> - Overall dimensions: 1'- 1-1/2" H x 1' - 4" W x 5" D - 2 Sided - Provides Restrooms / Elevator information - For use in International Concourses only : Accent Color Yellow - Pantone 123 	N/A
ST-252 Secondary Identification - Wall Mounted		
Domestic Concourses	International Concourses	N/A
		
<ul style="list-style-type: none"> - Overall dimensions: 7" H x 2' - 4" W x 1" D - Provides Elevator information - For use in Domestic Concourses only: Accent Color White 	<ul style="list-style-type: none"> - Overall dimensions: 7" H x 2' - 4" W x 1" D - Provides Elevator information - For use in International Concourses only : Accent Color Yellow - Pantone 123 	N/A
ST-254 Secondary Identification - Wall Mounted		
Domestic Concourses	International Concourses	N/A
		
<ul style="list-style-type: none"> - Overall dimensions: 10" H x 2' - 4" W x 1" D - Provides Restrooms information - For use in Domestic Concourses only: Accent Color White 	<ul style="list-style-type: none"> - Overall dimensions: 10" H x 2' - 4" W x 1" D - Provides Restrooms information - For use in International Concourses only : Accent Color Yellow - Pantone 123 	N/A

2.0 SIGN TYPE CONCOURSES

#	REVISION	DATE
1	Updated	05/06/16
2	Updated	08/24/17

2.3 Sign Type Index

ST-256 Secondary Identification - Wall Mounted		
Domestic Concourses	International Concourses	N/A
		
- Overall dimensions: 1'- 1" H x 8" W x 1/4" D - Provides Restroom information	- Overall dimensions: 1'- 1" H x 8" W x 1/4" D - Provides Restroom information	N/A
ST-258 Secondary Identification - Wall Mounted		
Domestic Concourses	International Concourses	N/A
		
- Overall dimensions: 7" H x 1'- 3-1/2" W x 1" D - Provides Gate Doors information	- Overall dimensions: 7" H x 1'- 3-1/2" W x 1" D - Provides Gate Doors information	N/A
ST-260 Primary Informational - Wall Mounted		
Domestic Concourses	International Concourses	N/A
		
- Overall dimensions: 1'- 6" H x 10" W x 1" D - Provides information on Concourse levels and functions	- Overall dimensions: 1'- 6" H x 10" W x 1" D - Provides information on Concourse levels and functions	N/A
N/A	N/A	N/A
N/A	N/A	N/A

2.0 SIGN TYPE CONCOURSES

#	REVISION	DATE
1	Updated	05/06/16
2	Updated	08/24/17

2.4 Sign Type Layouts

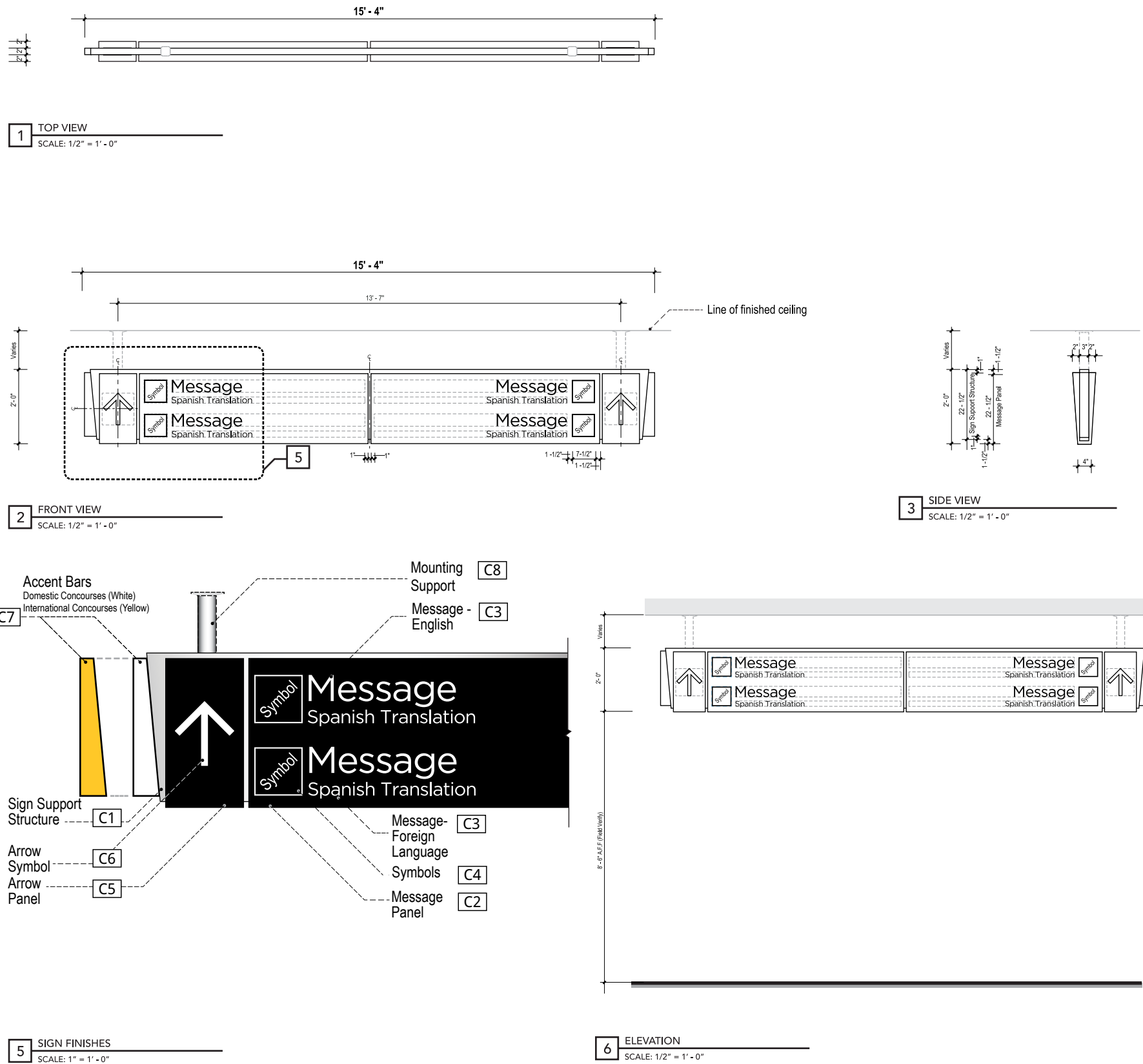

Directional ST-200

Descriptions: Primary Directional - 2 Directionals / 2 Levels of messaging / 2 sided.

Dimensions: 2'-0" High x 15' - 4" Wide x 7" Deep

Location: Concourses. Primary circulation corridors - perpendicular to the main pedestrian traffic flow.

Material: Seamless fabricated aluminum sign panel with removable message and arrow panels.

Lettering:
1. English - Gotham Book - 4" Cap height
2. Spanish - Gotham Book - 2" Cap height

Symbology: Refer to Section 1 - Graphics Standards

Colors:

- [C1]** Sign Support Structure
- Seamless fabricated .125" ALUMINUM (Satin Brushed).
- [C2]** Message Panel
- .25" seamless fabricated WHITE ACRYLIC (Translucent Sign Grade Polycarbonate) overlaid with opaque BLACK VINYL. LED Internally illuminated.
- [C3]** Messages - English
- Foreign Language
- Internally illuminated (White)
- [C4]** Symbols
- Internally illuminated (White)
- [C5]** Arrow Panels
- .25" seamless fabricated WHITE ACRYLIC (Translucent Sign Grade Polycarbonate) overlaid with opaque BLACK VINYL. LED Internally illuminated.
- [C6]** Arrow Symbol
- Internally illuminated (White)
- [C7]** Accent Bars
- .125" seamless bent acrylic with top and bottom caps. LED Internally illuminated. Accent Bar colors (Translucent Sign Grade Polycarbonate) corresponding to assigned accent colors for:
Domestic Concourses - White Acrylic
International Concourses - Pantone 123 (Yellow) - Locations T.B.D.: Assigned by Owner / Owner's Rep.
- [C8]** Mounting Support
- .080" x 3" square extruded ALUMINUM (SatinBrushed) tube to attach to existing building support sub-structure. Field verify.

Graphics: N/A
Mounting: Ceiling suspended
Illuminations: Internal
Remarks:

Notes:

- Signs with directional messages to Domestic Concourses will utilize "white" accent bar only (White Acrylic).
- Signs with messages for International Concourses will utilize "yellow" accent bar only (Pantone 123).
- Colors are not interchangeable, and cannot be substituted.

2.0 SIGN TYPE CONCOURSES

#	REVISION	DATE
1	Updated	05/06/16
2	Updated	08/24/17

2.4 Sign Type Layouts

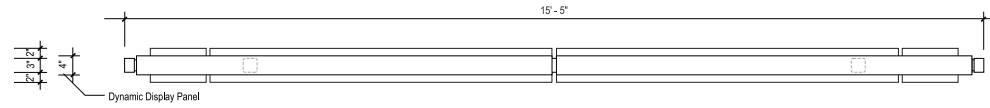

1 TOP VIEW
SCALE: 1/2" = 1' - 0"

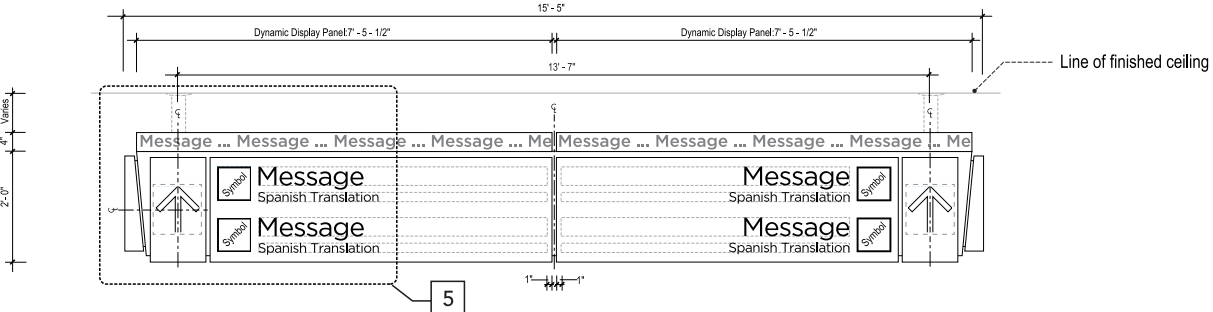

2 FRONT VIEW
SCALE: 1/2" = 1' - 0"

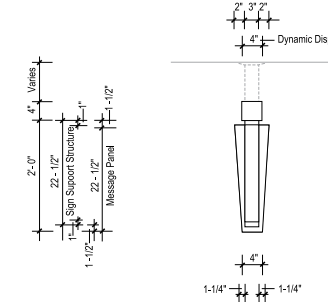

3 SIDE VIEW
SCALE: 1/2" = 1' - 0"

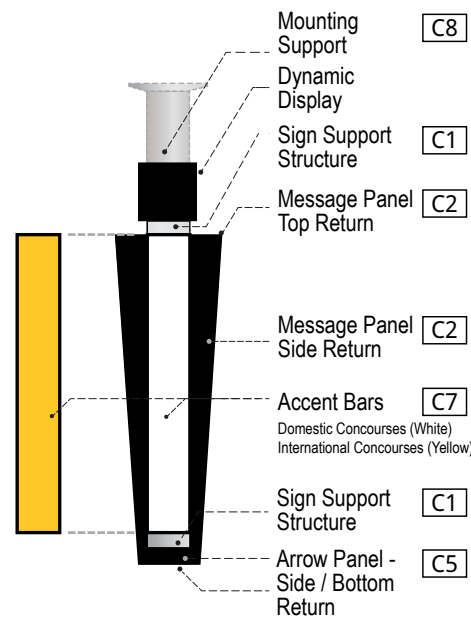

4 SIGN FINISHES - END VIEW
SCALE: 1-1/2" = 1' - 0"

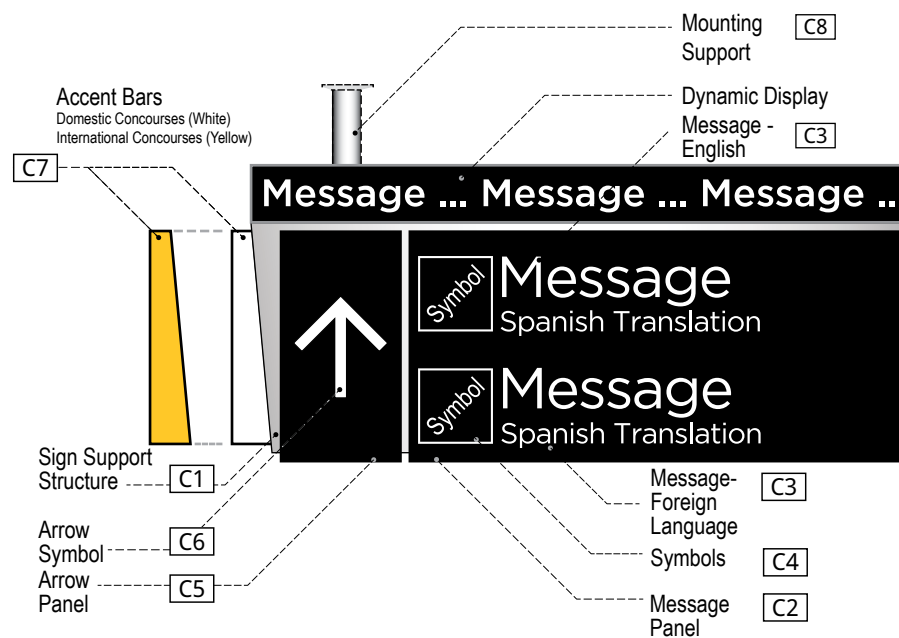

5 SIGN FINISHES
SCALE: 1" = 1' - 0"

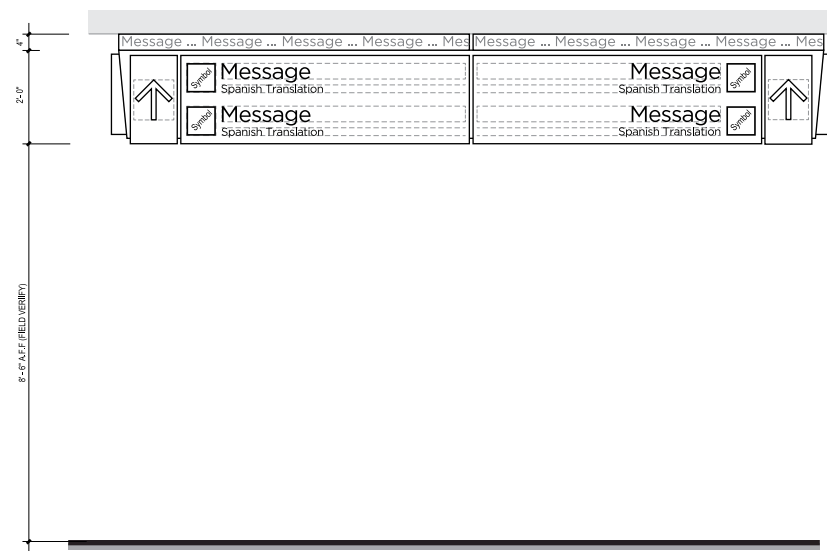

6 ELEVATION
SCALE: 1/2" = 1' - 0"

Colors con't.:

Remarks: Dynamic display messages will vary per Owner's request.

Directional ST-202

Descriptions: Primary Directional - (Dynamic)
2 Directionals / 2 Levels of messaging / 2 sided.

Dimensions: 2'- 4" High x 15' - 5" Wide x 7" Deep
Dynamic Display Bar: 4" H x 7'- 5-1/2"W x 4" D

Location: Concourses. Primary circulation corridors, and at key decision points - perpendicular to the main pedestrian traffic flow.

Material: Seamless fabricated aluminum sign panel with removable message and arrow panels.

Lettering: 1. English - Gotham Book - 4" Cap height
2. Spanish - Gotham Book - 2" Cap height

Symbology: Refer to Section 1 - Graphics Standards

- Colors:**
- C1** • Sign Support Structure - Seamless fabricated .125" ALUMINUM (Satin Brushed)
 - C2** • Message Panel - .25" seamless fabricated WHITE ACRYLIC (Translucent Sign Grade Polycarbonate) overlaid with opaque BLACK VINYL. LED Internally illuminated.
 - C3** • Messages - English and Foreign Language - Internally illuminated (White)
 - C4** • Symbols - Internally illuminated (White)
 - C5** • Arrow Panels - .25" seamless fabricated WHITE ACRYLIC (Translucent Sign Grade Polycarbonate) overlaid with opaque BLACK VINYL. LED Internally illuminated.
 - C6** • Arrow Symbol - Internally illuminated (White)
 - C7** • Accent Bars - .125" seamless bent acrylic with top and bottom caps. LED Internally illuminated. Accent Bar colors (Translucent Sign Grade Polycarbonate) corresponding to assigned accent colors for:
Domestic Concourses - White Acrylic
International Concourses - Pantone 123 (Yellow) - Locations T.B.D.: Assigned by Owner / Owner's Rep.
 - C8** • Mounting Support - .080" x 3" square extruded ALUMINUM (SatinBrushed) tube to attach to existing building support sub-structure. Field verify.

Graphics: N/A
Mounting: Ceiling suspended
Illuminations: Internal

- Notes:**
1. Signs with directional messages to Domestic Concourses will utilize "white" accent bar only (White Acrylic).
 2. Signs with messages for International Concourses will utilize "yellow" accent bar only (Pantone 123).
 3. Colors are not interchangeable, and cannot be substituted.
 4. Dynamic Display color will vary, depending on location.

2.0 SIGN TYPE CONCOURSES

#	REVISION	DATE
1	Updated	05/06/16
2	Updated	08/24/17

2.4 Sign Type Layouts

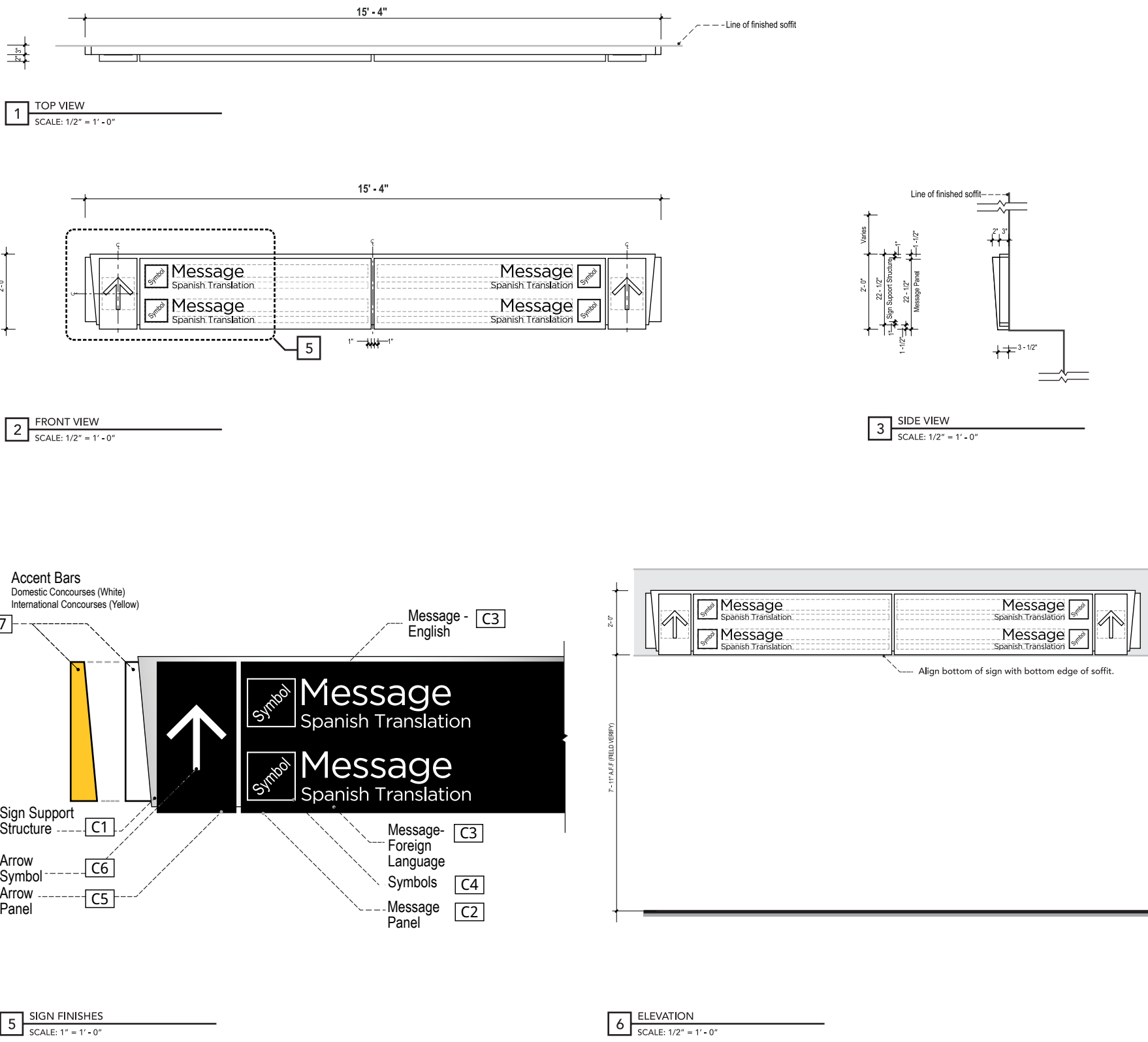

Directional ST-204

Descriptions: Primary Directional - 2 Directionals / 2 Levels of messaging / 2 sided.

Dimensions: 2'- 0" High x 15' - 4" Wide x 5" Deep

Location: Concourse T. Midpoint escalator lobby - perpendicular to the main pedestrian traffic flow.

Material: Seamless fabricated aluminum sign panel with removable message and arrow panels.

Lettering:
1. English - Gotham Book - 4" Cap height
2. Spanish - Gotham Book - 2" Cap height

Symbology: Refer to Section 1 - Graphics Standards

Colors:

- C1** • Sign Support Structure
- Seamless fabricated .125" ALUMINUM (Satin Brushed)
- C2** • Message Panel
- .25" seamless fabricated WHITE ACRYLIC (Translucent Sign Grade Polycarbonate) overlaid with opaque BLACK VINYL. LED Internally illuminated.
- C3** • Messages - English and Foreign Language
- Internally illuminated (White)
- C4** • Symbols
- Internally illuminated (White)
- C5** • Arrow Panels
- .25" seamless fabricated WHITE ACRYLIC (Translucent Sign Grade Polycarbonate) overlaid with opaque BLACK VINYL. LED Internally illuminated.
- C6** • Arrow Symbol
- Internally illuminated (White)
- C7** • Accent Bars
- .125" seamless bent acrylic with top and bottom caps. LED Internally illuminated. Accent Bar colors (Translucent Sign Grade Polycarbonate) corresponding to assigned accent colors for:
Domestic Concourses - White Acrylic
International Concourses - Pantone 123 (Yellow) - Locations T.B.D.: Assigned by Owner / Owner's Rep.

Graphics: N/A
Mounting: Soffit Mounted
Illuminations: Internal
Remarks: Soffit Mount:
 - Soffit at decision point
 - Maintain 7' - 11" A.F.F

Notes:
 1. Signs with directional messages to Domestic Concourses will utilize "white" accent bar only (White Acrylic).
 2. Signs with messages for International Concourses will utilize "yellow" accent bar only (Pantone 123).
 3. Colors are not interchangeable, and cannot be substituted.

2.0 SIGN TYPE CONCOURSES

#	REVISION	DATE
1	Updated	05/06/16
2	Updated	08/24/17

2.4 Sign Type Layouts

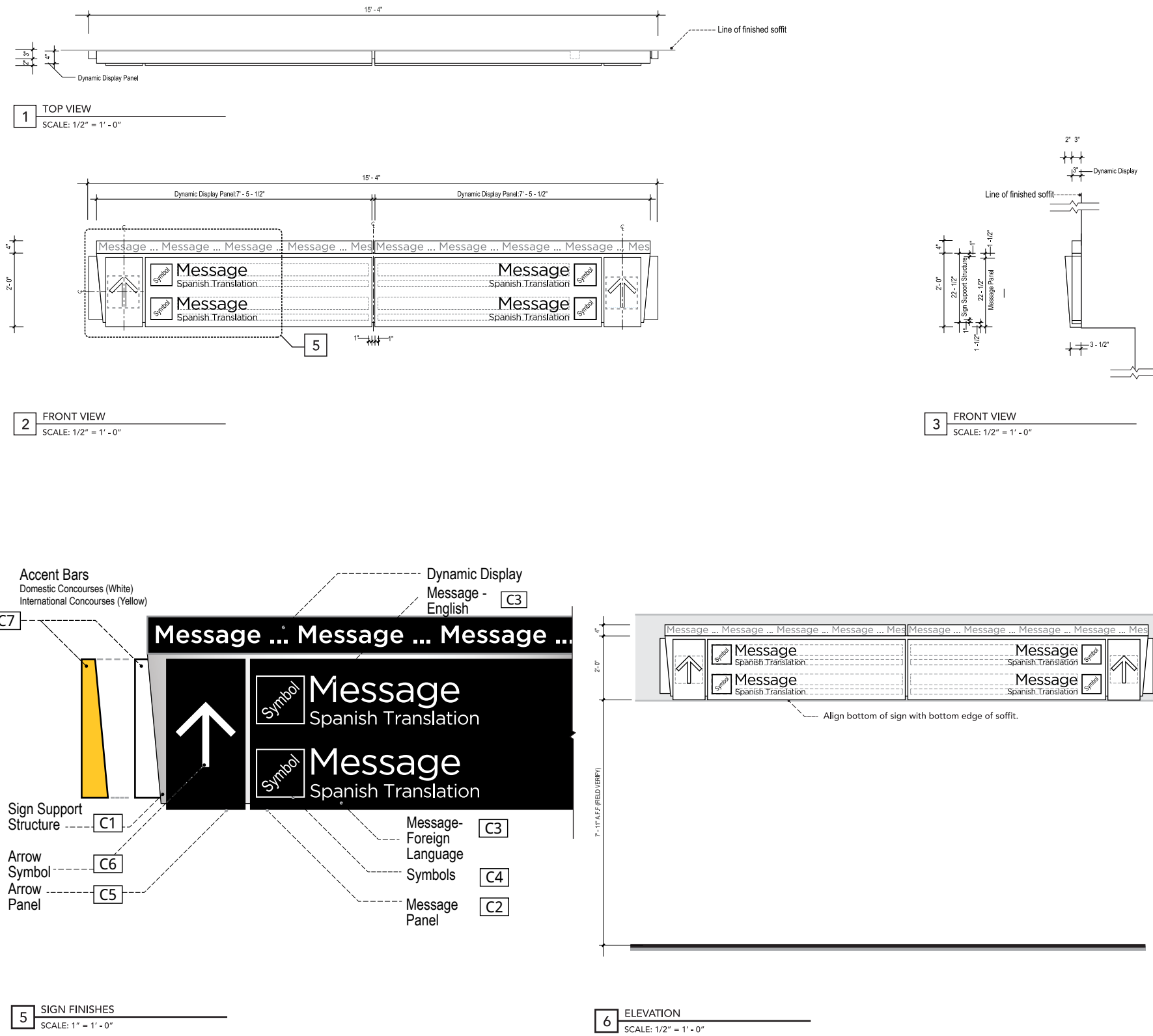

Directional ST-206

- Descriptions:** Primary Directional - (Dynamic)
2 Directionals / 2 Levels of messaging / 1 sided.
- Dimensions:** 2'- 4" High x 15' - 4" Wide x 5" Deep
Dynamic Display Bar: 4" H x 7'- 5-1/2"W x 4" D
- Location:** Concourses. Midpoint escalator lobby - perpendicular to the main pedestrian traffic flow.
- Material:** Seamless fabricated aluminum sign panel with removable message and arrow panels.
- Lettering:**
1. English - Gotham Book - 4" Cap height
2. Spanish - Gotham Book - 2" Cap height
- Symbology:** Refer to Section 1 - Graphics Standards
- Colors:**
- C1** • Sign Support Structure
- Seamless fabricated .125" ALUMINUM (Satin Brushed)
 - C2** • Message Panel
- .25" seamless fabricated WHITE ACRYLIC (Translucent Sign Grade Polycarbonate) overlaid with opaque BLACK VINYL. LED Internally illuminated.
 - C3** • Messages - English and Foreign Language
- Internally illuminated (White)
 - C4** • Symbols
- Internally illuminated (White)
 - C5** • Arrow Panels
- .25" seamless fabricated WHITE ACRYLIC (Translucent Sign Grade Polycarbonate) overlaid with opaque BLACK VINYL. LED Internally illuminated.
 - C6** • Arrow Symbol
- Internally illuminated (White)
 - C7** • Accent Bars
- .125" seamless bent acrylic with top and bottom caps. LED Internally illuminated. Accent Bar colors (Translucent Sign Grade Polycarbonate) corresponding to assigned accent colors for:
Domestic Concourses - White Acrylic
International Concourses - Pantone 123 (Yellow) - Locations T.B.D.: Assigned by Owner / Owner's Rep.
- Graphics:** N/A
Mounting: Soffit Mounted
Illuminations: Internal
Remarks:
- Dynamic messages will vary per Owner's request
 - Soffit Mount:
- Soffit at decision point
- Maintain 7' - 11" A.F.F

Notes:

1. Signs with directional messages to Domestic Concourses will utilize "white" accent bar only (White Acrylic).
2. Signs with messages for International Concourses will utilize "yellow" accent bar only (Pantone 123).
3. Colors are not interchangeable, and cannot be substituted.
4. Dynamic Display color will vary, depending on location.

2.0 SIGN TYPE CONCOURSES

#	REVISION	DATE
1	Updated	05/06/16
2	Updated	08/24/17

2.4 Sign Type Layouts

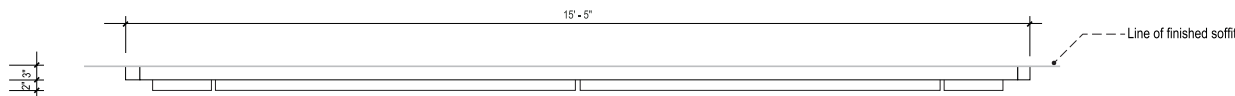

1 TOP VIEW
SCALE: 1/2" = 1' - 0"

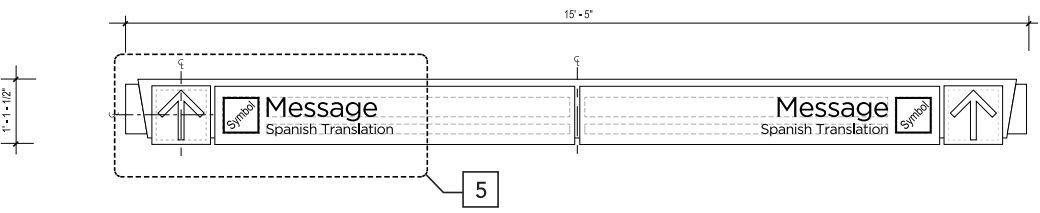

2 FRONT VIEW
SCALE: 1/2" = 1' - 0"

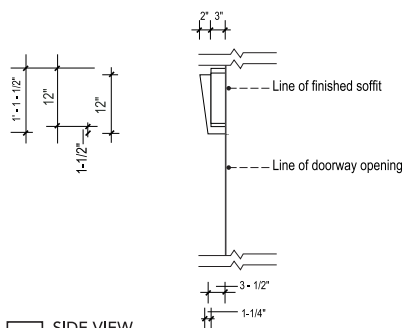

3 SIDE VIEW
SCALE: 1/2" = 1' - 0"

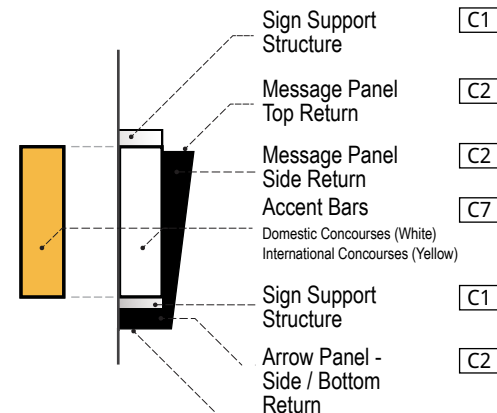

4 SIGN FINISHES - END VIEW
SCALE: 1-1/2" = 1' - 0"

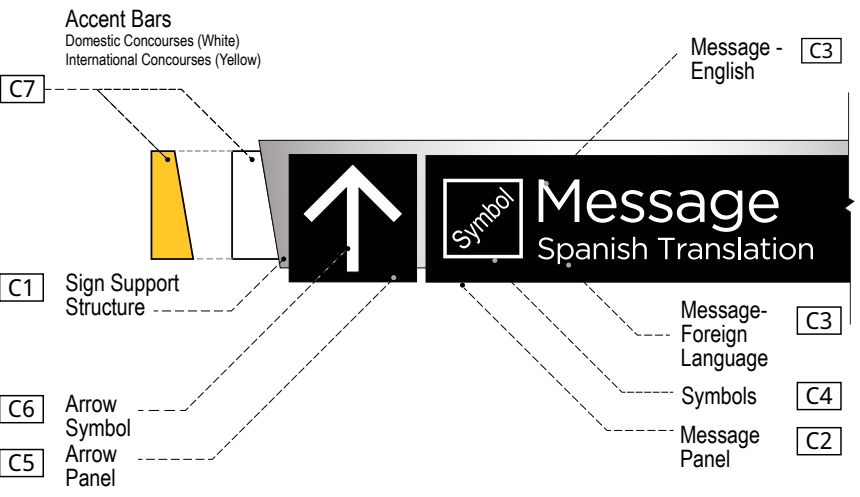

5 SIGN FINISHES
SCALE: 1" = 1' - 0"

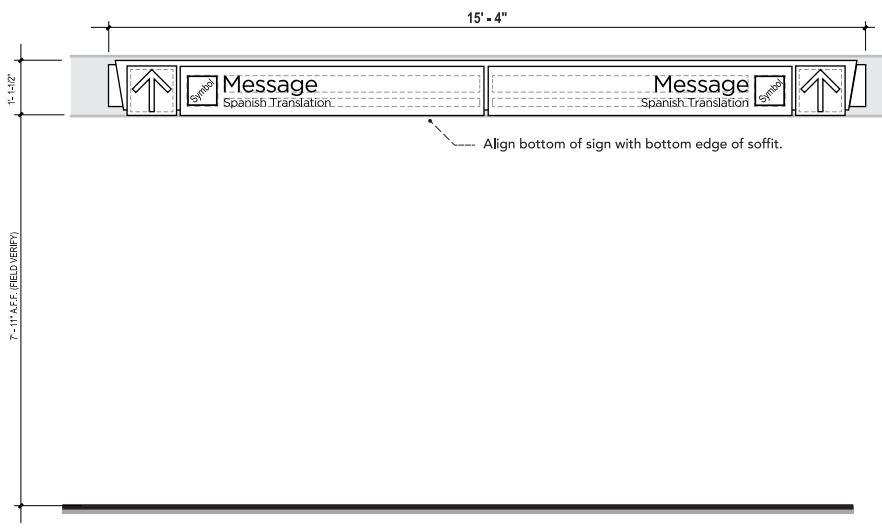

6 ELEVATION
SCALE: 1/2" = 1' - 0"

Directional ST-212

Descriptions: Primary Directional - 2 Directionals / 1 Levels of messaging / 1 sided.

Dimensions: 1'- 1-1/2" High x 15' -5" Wide x 5" Deep

Location: Concourse T. Midpoint escalator lobby - perpendicular to the main pedestrian traffic flow.

Material: Seamless fabricated aluminum sign panel with removable message and arrow panels.

Lettering:
1. English - Gotham Book - 4" Cap height
2. Spanish - Gotham Book - 2" Cap height

Symbology: Refer to Section 1 - Graphics Standards

- Colors:**
- C1** • Sign Support Structure - Seamless fabricated .125" ALUMINUM (Satin Brushed)
 - C2** • Message Panel - .25" seamless fabricated WHITE ACRYLIC (Translucent Sign Grade Polycarbonate) overlaid with opaque BLACK VINYL. LED Internally illuminated.
 - C3** • Messages - English and Foreign Language - Internally illuminated (White)
 - C4** • Symbols - Internally illuminated (White)
 - C5** • Arrow Panels - .25" seamless fabricated WHITE ACRYLIC (Translucent Sign Grade Polycarbonate) overlaid with opaque BLACK VINYL. LED Internally illuminated.
 - C6** • Arrow Symbol - Internally illuminated (White)
 - C7** • Accent Bars - .125" seamless bent acrylic with top and bottom caps. LED Internally illuminated. Accent Bar colors (Translucent Sign Grade Polycarbonate) corresponding to assigned accent colors for:
Domestic Concourses - White Acrylic
International Concourses - Pantone 123 (Yellow) - Locations T.B.D.: Assigned by Owner / Owner's Rep.

Graphics: N/A
Mounting: Soffit Mounted
Illuminations: Internal
Remarks: Soffit Mount:
- Soffit at decision point
- Maintain 7' - 11" A.F.F

Notes:

- Signs with directional messages to Domestic Concourses will utilize "white" accent bar only (White Acrylic).
- Signs with messages for International Concourses will utilize "yellow" accent bar only (Pantone 123).
- Colors are not interchangeable, and cannot be substituted.

2.0 SIGN TYPE CONCOURSES

#	REVISION	DATE
1	Updated	05/06/16
2	Updated	08/24/17

2.4 Sign Type Layouts

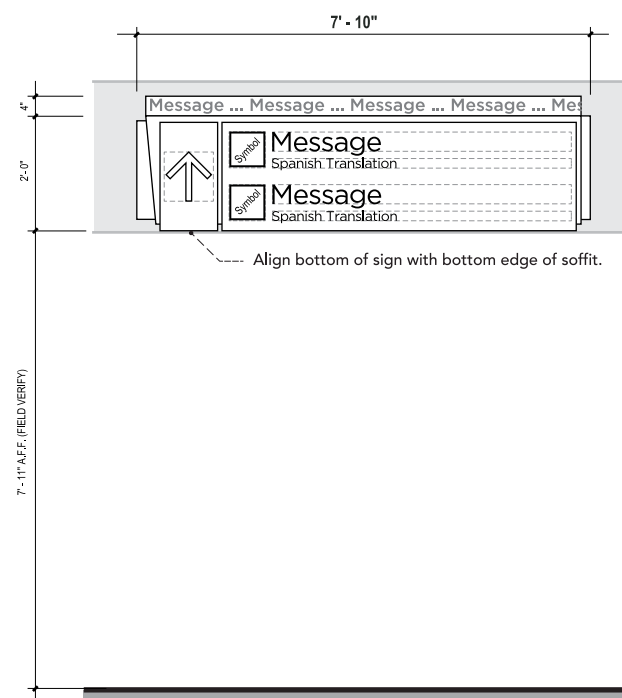
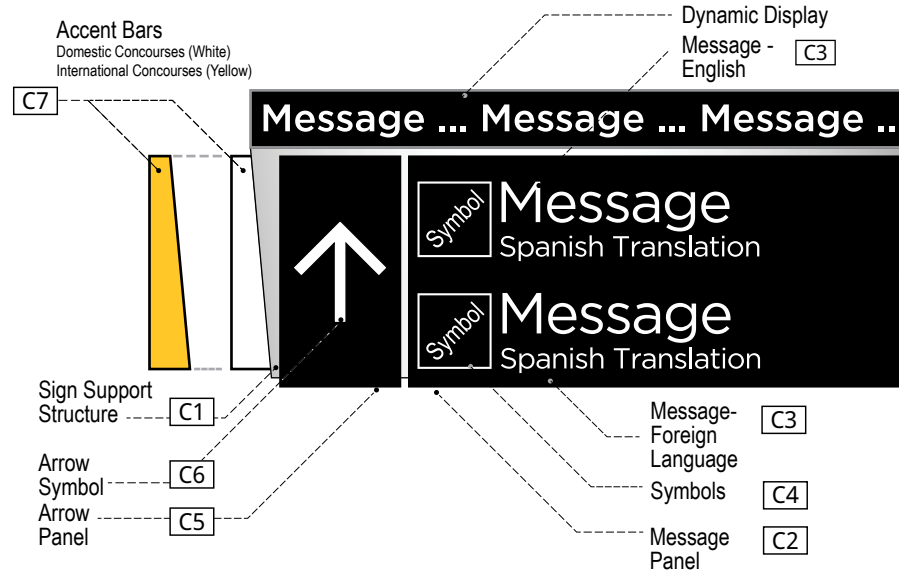
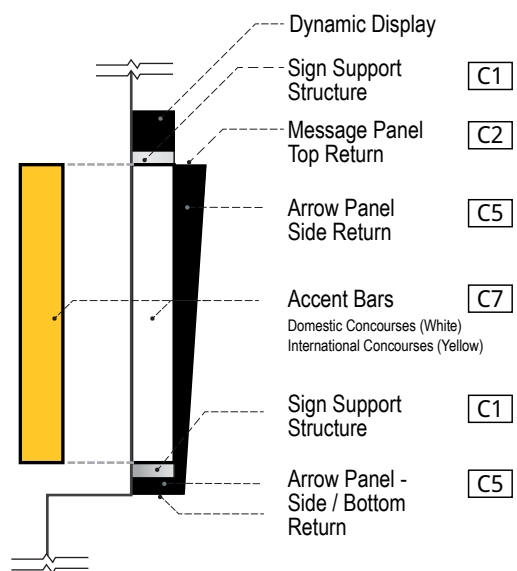
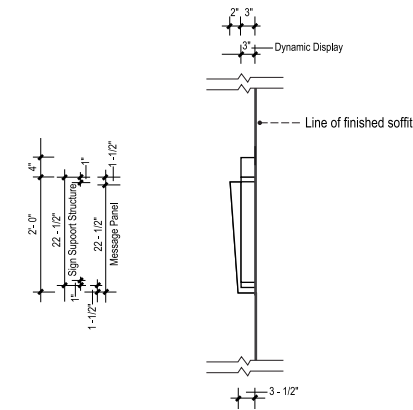
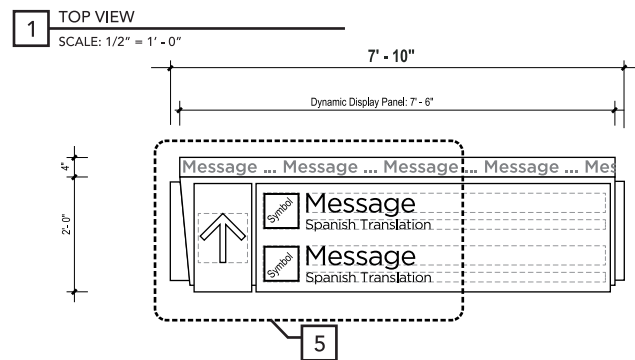
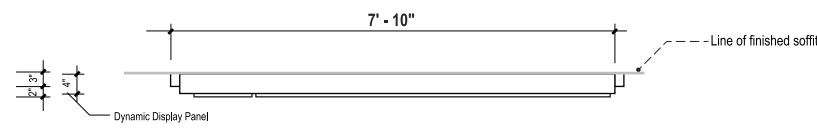

Directional **ST-222**

Descriptions: Secondary Directional - (Dynamic).
1 Directional / 2 Levels of messaging / 1 sided.

Dimensions: 2'- 4" High x 7' - 10" Wide x 5" Deep
Dynamic Display Bar: 4" H x 7'- 6" W x 4" D

Location: Concourse T. Midpoint escalator lobby - perpendicular to the main pedestrian traffic flow.

Material: Seamless fabricated aluminum sign panel with removable message and arrow panels.

Lettering:
1. English - Gotham Book - 4" Cap height
2. Spanish - Gotham Book - 2" Cap height

Symbology: Refer to Section 1 - Graphics Standards

- Colors:**
- C1** • Sign Support Structure
- Seamless fabricated .125" ALUMINUM (Satin Brushed)
 - C2** • Message Panel
- .25" seamless fabricated WHITE ACRYLIC (Translucent Sign Grade Polycarbonate) overlaid with opaque BLACK VINYL. LED Internally illuminated.
 - C3** • Messages - English and Foreign Language
- Internally illuminated (White)
 - C4** • Symbols
- Internally illuminated (White)
 - C5** • Arrow Panels
- .25" seamless fabricated WHITE ACRYLIC (Translucent Sign Grade Polycarbonate) overlaid with opaque BLACK VINYL. LED Internally illuminated.
 - C6** • Arrow Symbol
- Internally illuminated (White)
 - C7** • Accent Bars
- .125" seamless bent acrylic with top and bottom caps. LED Internally illuminated. Accent Bar colors (Translucent Sign Grade Polycarbonate) corresponding to assigned accent colors for:
Domestic Concourses - White Acrylic
International Concourses - Pantone 123 (Yellow) - Locations T.B.D.: Assigned by Owner / Owner's Rep.

Graphics: N/A
Mounting: Wall / Soffit Mounted
Illuminations: Internal
Remarks:
- Dynamic messages will vary per Owner's request
- Soffit Mount:
- Soffit at decision point
- Maintain 7' - 11" A.F.F

Notes:
1. Signs with directional messages to Domestic Concourses will utilize "white" accent bar only (White Acrylic).
2. Signs with messages for International Concourses will utilize "yellow" accent bar only (Pantone 123).
3. Colors are not interchangeable, and cannot be substituted.
4. Dynamic Display color will vary, depending on location.

2.0 SIGN TYPE CONCOURSES

#	REVISION	DATE
1	Updated	05/06/16
2	Updated	08/24/17

2.4 Sign Type Layouts

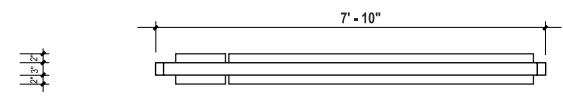

1 TOP VIEW
SCALE: 1/2" = 1' - 0"

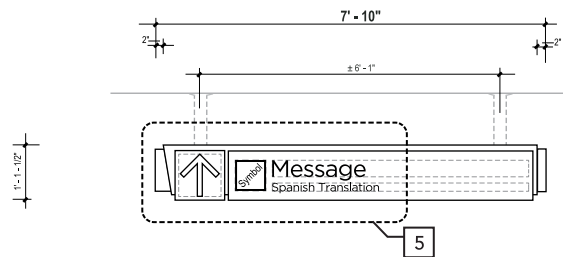

2 FRONT VIEW
SCALE: 1/2" = 1' - 0"

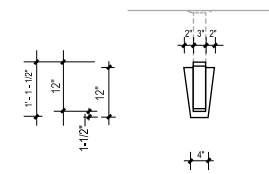

3 SIDE VIEW
SCALE: 1/2" = 1' - 0"

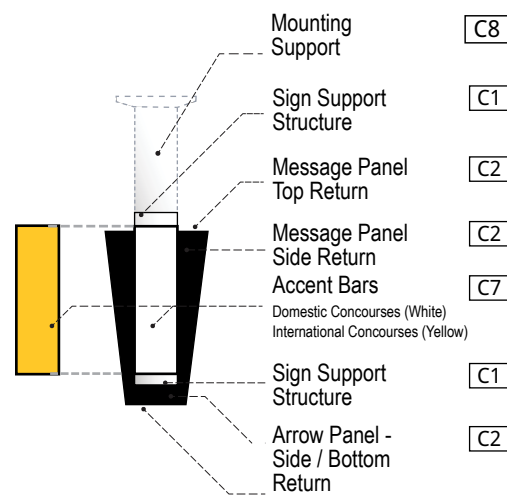

4 END VIEW
SCALE: 1-1/2" = 1' - 0"

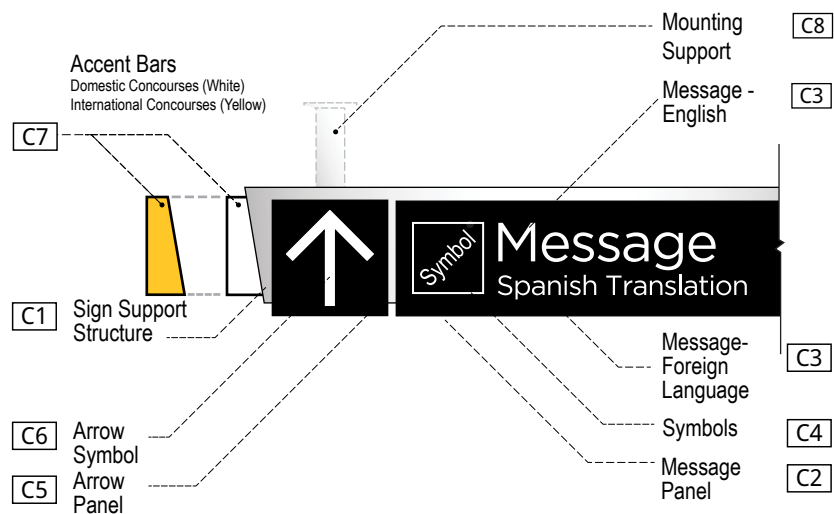

5 SIGN FINISHES
SCALE: 1" = 1' - 0"

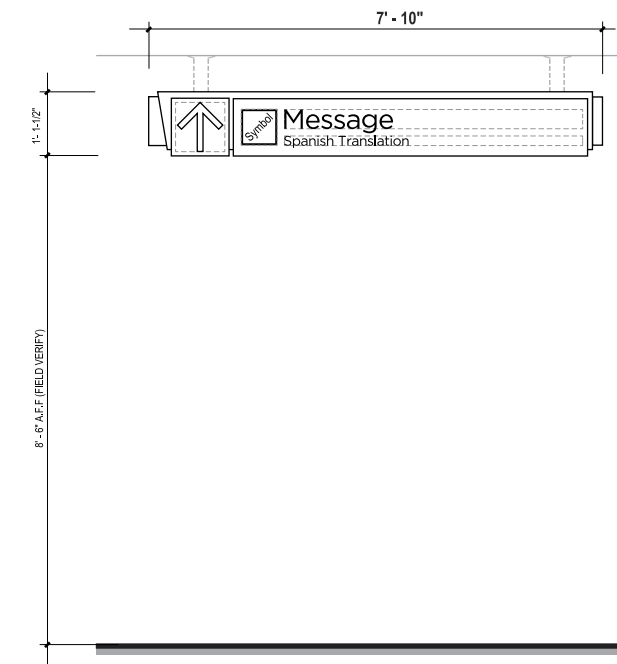

6 ELEVATION
SCALE: 1/2" = 1' - 0"

Directional ST-224

- Descriptions:** Secondary Directional - 1 Directional / 1 Level of messaging / 1 sided.
- Dimensions:** 1'- 1-1/2" High x 7' - 10" Wide x 5" Deep
- Location:** Concourses. Hold rooms circulation corridor - perpendicular to the main pedestrian traffic flow.
- Material:** Seamless fabricated aluminum sign panel with removable message and arrow panels.
- Lettering:**
1. English - Gotham Book - 4" Cap height
2. Spanish - Gotham Book - 2" Cap height
- Symbology:** Refer to Section 1 - Graphics Standards
- Colors:**
- C1** • Sign Support Structure - Seamless fabricated .125" ALUMINUM (SatinBrushed)
 - C2** • Message Panel - .25" seamless fabricated WHITE ACRYLIC (Translucent Sign Grade Polycarbonate) overlaid with opaque BLACK VINYL. LED Internally illuminated.
 - C3** • Messages - English and Foreign Language - Internally illuminated (White)
 - C4** • Symbols - Internally illuminated (White)
 - C5** • Arrow Panels - .25" seamless fabricated WHITE ACRYLIC (Translucent Sign Grade Polycarbonate) overlaid with opaque BLACK VINYL. LED Internally illuminated.
 - C6** • Arrow Symbol - Internally illuminated (White)
 - C7** • Accent Bars - .125" seamless bent acrylic with top and bottom caps. LED Internally illuminated. Accent Bar colors (Translucent Sign Grade Polycarbonate) corresponding to assigned accent colors for:
Domestic Concourses - White Acrylic
International Concourses - Pantone 123 (Yellow) - Locations T.B.D.: Assigned by Owner / Owner's Rep.
 - C8** • Mounting Support .080" x 3" square extruded ALUMINUM tube to attach to existing building support sub-structure. Field verify.

Graphics: N/A
Mounting: Ceiling Suspended
Illuminations: Internal
Remarks:

- Notes:**
- Signs with directional messages to Domestic Concourses will utilize "white" accent bar only (White Acrylic).
 - Signs with messages for International Concourses will utilize "yellow" accent bar only (Pantone 123).
 - Colors are not interchangeable, and cannot be substituted.

2.0 SIGN TYPE CONCOURSES

#	REVISION	DATE
1	Updated	05/06/16
2	Updated	08/24/17

2.4 Sign Type Layouts

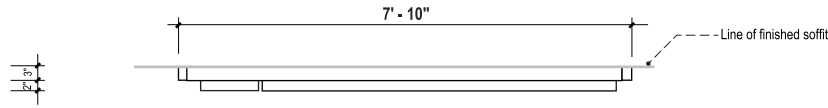

1 TOP VIEW
SCALE: 1/2" = 1' - 0"

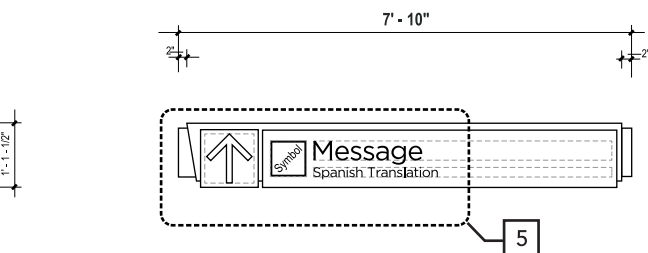

2 FRONT VIEW
SCALE: 1/2" = 1' - 0"

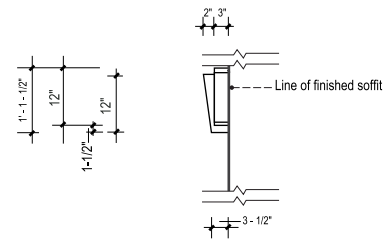

3 SIDE VIEW
SCALE: 1/2" = 1' - 0"

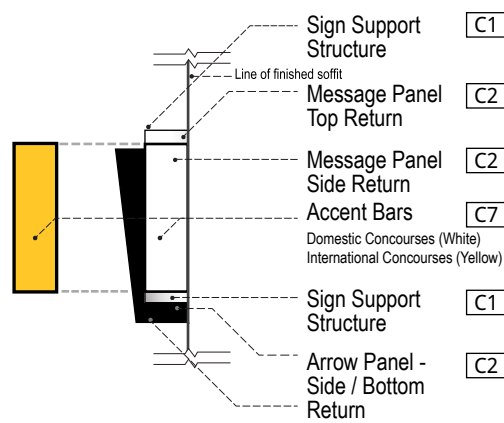

4 SIDE VIEW
SCALE: 1-1/2" = 1' - 0"

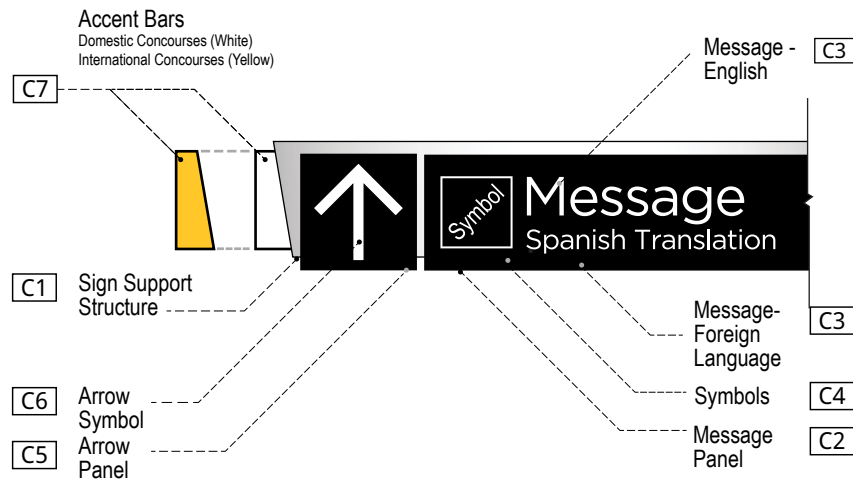

5 SIGN FINISHES
SCALE: 1" = 1' - 0"

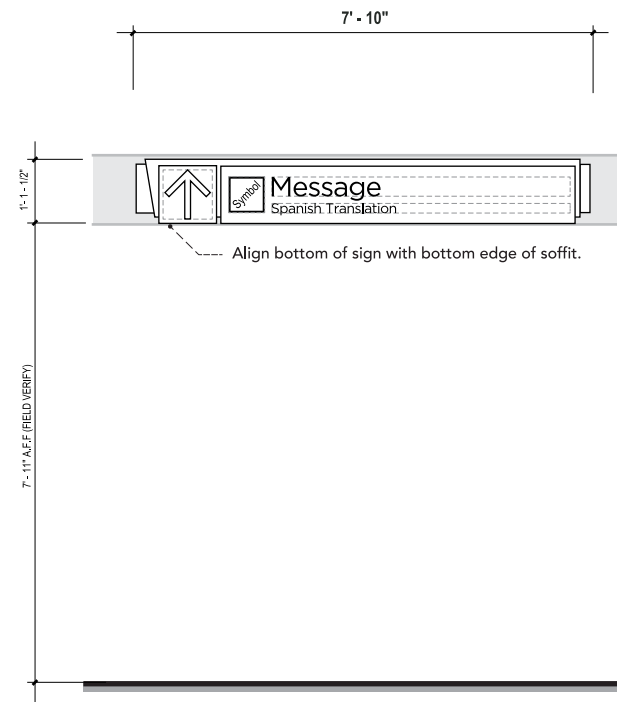

6 ELEVATION
SCALE: 1/2" = 1' - 0"

Directional ST-228

Descriptions: Secondary Directional - 1 Directional / 1 Level of messaging / 1 sided.

Dimensions: 1'- 1-1/2" High x 7' - 10" Wide x 5" Deep

Location: Concourse T. Midpoint escalator lobby - perpendicular to the main pedestrian traffic flow.

Material: Seamless fabricated aluminum sign panel with removable message and arrow panels.

Lettering:
1. English - Gotham Book - 4" Cap height
2. Spanish - Gotham Book - 2" Cap height

Symbology: Refer to Section 1 - Graphics Standards

- Colors:**
- C1** • Sign Support Structure
- Seamless fabricated .125" ALUMINUM (Satin Brushed)
 - C2** • Message Panel
- .25" seamless fabricated WHITE ACRYLIC (Translucent Sign Grade Polycarbonate) overlaid with opaque BLACK VINYL. LED Internally illuminated.
 - C3** • Messages - English and Foreign Language
- Internally illuminated (White)
 - C4** • Symbols
- Internally illuminated (White)
 - C5** • Arrow Panels
- .25" seamless fabricated WHITE ACRYLIC (Translucent Sign Grade Polycarbonate) overlaid with opaque BLACK VINYL. LED Internally illuminated.
 - C6** • Arrow Symbol
- Internally illuminated (White)
 - C7** • Accent Bars
- .125" seamless bent acrylic with top and bottom caps. LED Internally illuminated. Accent Bar colors (Translucent Sign Grade Polycarbonate) corresponding to assigned accent colors for:
Domestic Concourses - White Acrylic
International Concourses - Pantone 123 (Yellow) - Locations T.B.D.: Assigned by Owner / Owner's Rep.

Graphics: N/A
Mounting: Soffit Mounted
Illuminations: Internal
Remarks: Soffit Mount:
- Soffit at decision point
- Maintain 7' - 11" A.F.F

- Notes:**
- Signs with directional messages to Domestic Concourses will utilize "white" accent bar only (White Acrylic).
 - Signs with messages for International Concourses will utilize "yellow" accent bar only (Pantone 123).
 - Colors are not interchangeable, and cannot be substituted.

2.0 SIGN TYPE CONCOURSES

#	REVISION	DATE
1	Updated	05/06/16
2	Updated	08/24/17

2.4 Sign Type Layouts

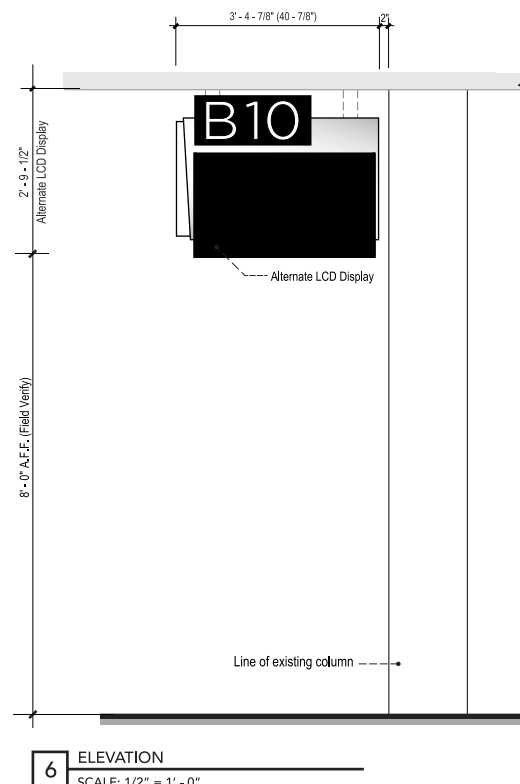
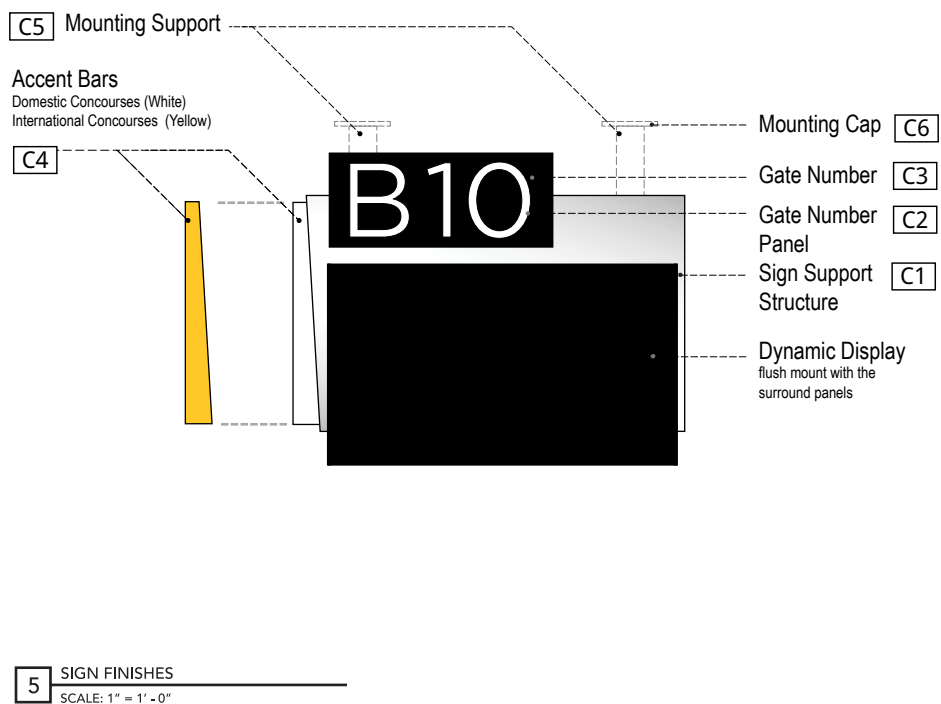
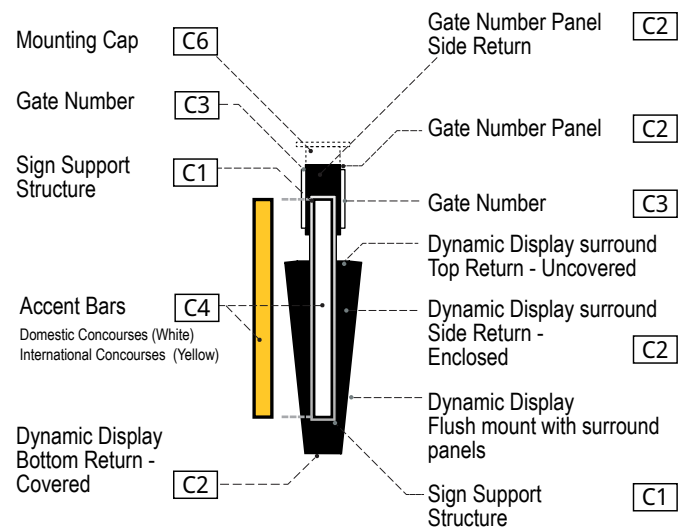
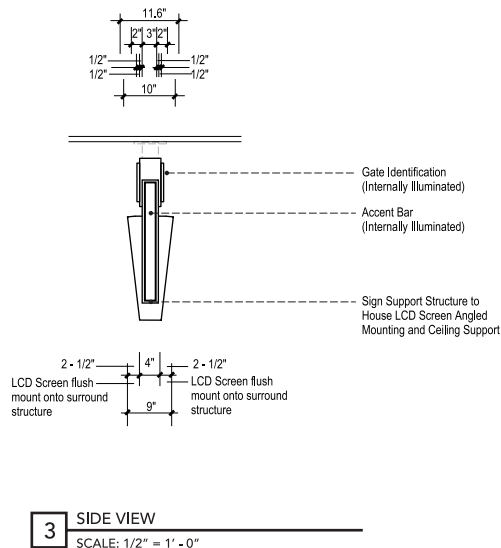
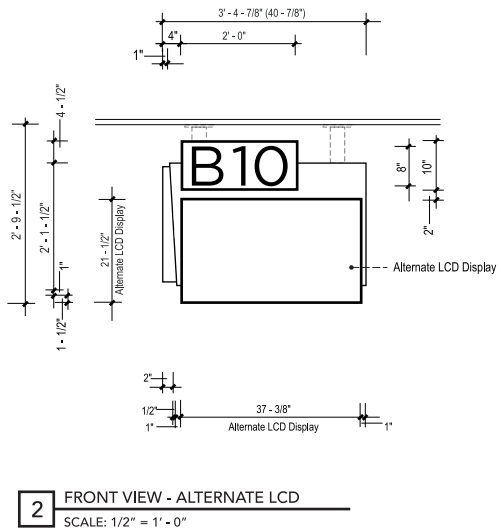
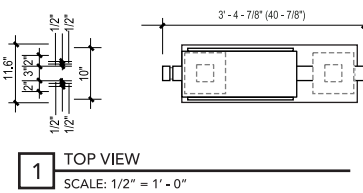

Identification ST-240

Descriptions: Primary Identification (Dynamic)

Dimensions: 2'- 9-1/2" High x 3' - 4-7/8" Wide x 11.6" Deep
Dynamic Display Panel: 1'-7-1/2" H x 3'-0" W x 1" D - housed flush with the dynamic panel surround.

Location: Concourses. Primary circulation corridors - perpendicular to the main pedestrian traffic flow.

Material: Seamless fabricated aluminum sign panel with removable number panels.

Lettering: 1. English - Gotham Book - 8" Cap height

Symbology: N/A

Colors:

- C1** Sign Support Structure - Seamless fabricated .125" ALUMINUM (Satin Brushed)
- C2** Gate Number Panel - .125" seamless fabricated clear acrylic overlaid with BLACK VINYL.
- C3** Gate Number - Dimensional Fabricated dimensional WHITE ACRYLIC (Translucent Sign Grade Polycarbonate numbers and letters. LED internally illuminated.
- C4** Accent Bars - .125" seamless bent acrylic with top and bottom caps. LED Internally illuminated. Accent Bar colors (Translucent Sign Grade Polycarbonate) corresponding to assigned accent colors for:
Domestic Concourses - White Acrylic
International Concourses - Pantone 123 (Yellow) - Locations T.B.D.: Assigned by Owner / Owner's Rep.
- C5** Mounting Support - .080" x 3" square extruded ALUMINUM tube (Satin Brushed) to attach to existing building support sub-structure. Field verify.
- C6** Mounting Cap - .080" x 4" square brushed ALUMINUM cap to match sign support finish.

Graphics: N/A
Mounting: Ceiling Suspended
Illuminations: Internal
Remarks: Dynamic messages will vary

Note:
1. Colors are not interchangeable, and cannot be substituted.

2.0 SIGN TYPE CONCOURSES

#	REVISION	DATE
1	Updated	05/06/16
2	Updated	08/24/17

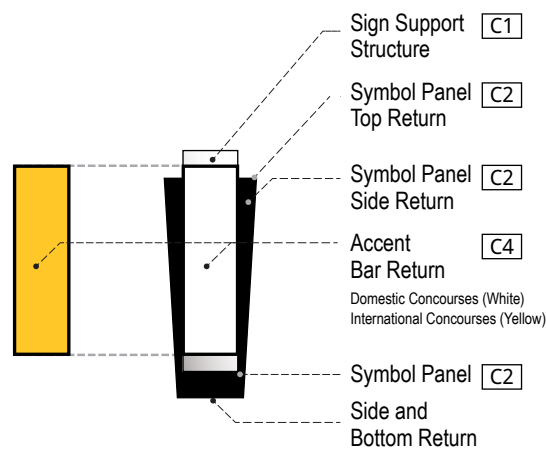

5 SIGN FINISHES - END VIEW
SCALE: NTS

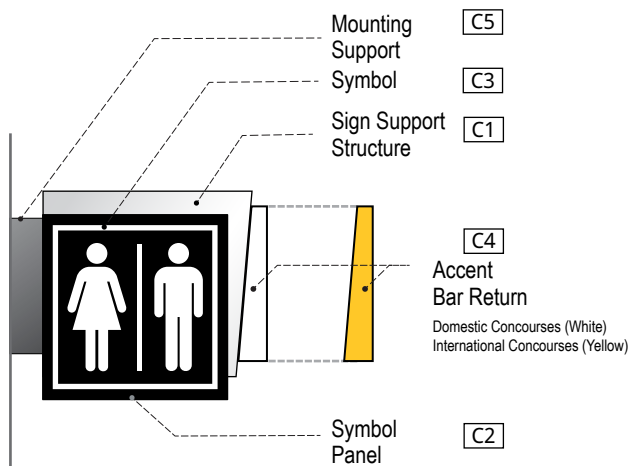

6 SIGN FINISHES
SCALE: NTS

2.4 Sign Type Layouts

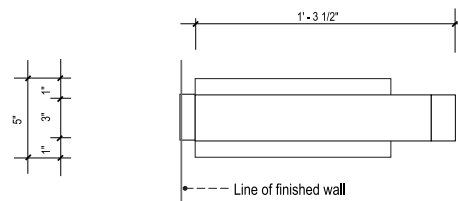

1 TOP VIEW
SCALE: 1-1/2" = 1' - 0"

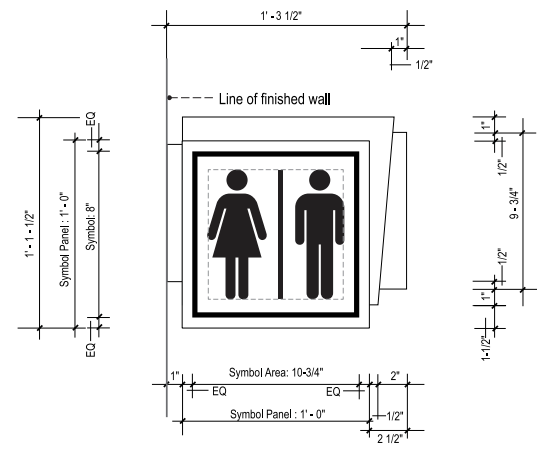

2 FRONT VIEW - RESTROOMS
SCALE: 1-1/2" = 1' - 0"

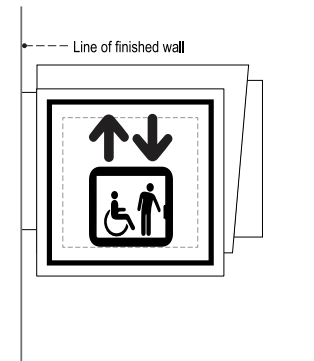

3 FRONT VIEW - ELEVATOR
SCALE: 1-1/2" = 1' - 0"

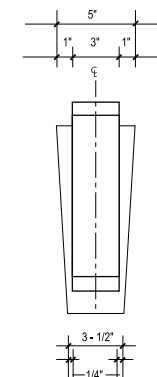

4 SIDE VIEW
SCALE: 1-1/2" = 1' - 0"

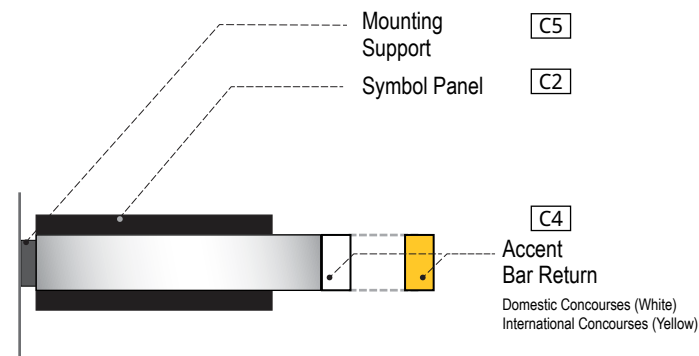

7 TOP VIEW
SCALE: 1-1/2" = 1' - 0"

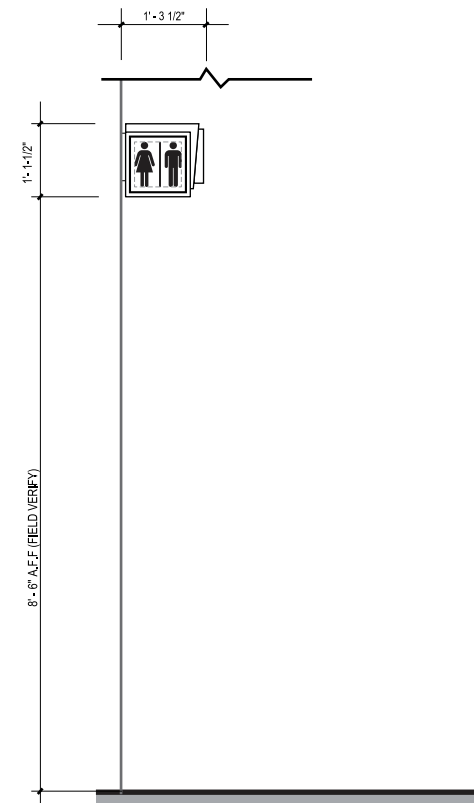

8 ELEVATION
SCALE: 1-1/2" = 1' - 0"

Identification ST-250

Descriptions: Secondary Identification

Dimensions: 1'- 1-1/2" High x 1' - 4" Wide x 5" Deep

Location: Concourses. Primary circulation corridors - perpendicular to the main pedestrian traffic flow.

Material: Seamless fabricated aluminum sign panel with removable symbol panels.

Lettering: N/A

Symbology: Refer to Section 1 - Graphics Standards

Colors:

- C1** Sign Support Structure - Seamless fabricated .040 thick satin brushed aluminum
- C2** Symbol Panel - .25" thick seamless fabricated White acrylic (Sign Grade Polycarbonate) overlaid with opaque Black vinyl - Internally illuminated
- C3** Symbol - Internally illuminated (White)
- C4** Accent Bars - ".125" seamless bent acrylic with top and bottom caps. LED Internally illuminated. Accent Bars (Translucent Sign Grade Polycarbonate) corresponding to assigned accent colors for:
Domestic Concourses - White Acrylic
International Concourses - Pantone 123 (Yellow) - Locations T.B.D.: Assigned by Owner / Owner's Rep.
- C5** Mounting Support - Seamless fabricated .040 thick satin brushed aluminum

Graphics: N/A

Mounting: Flag Mounted

Illuminations: Internal

Remarks: N/A

Note:
1. Colors are not interchangeable, and cannot be substituted.

2.0 SIGN TYPE CONCOURSES

#	REVISION	DATE
1	Updated	05/06/16
2	Updated	08/24/17

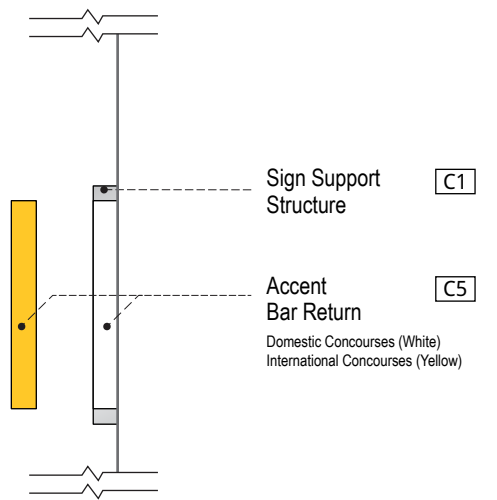

5 SIGN FINISHES
SCALE: NTS

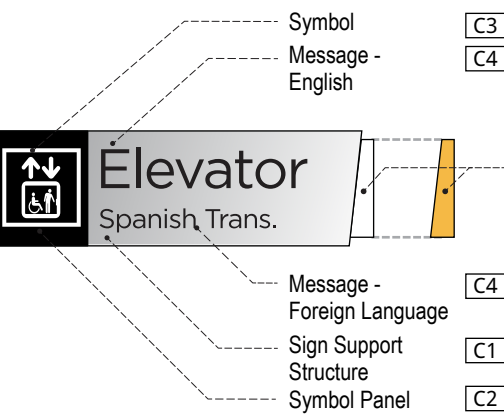

6 SIGN FINISHES
SCALE: NTS

2.4 Sign Type Layouts

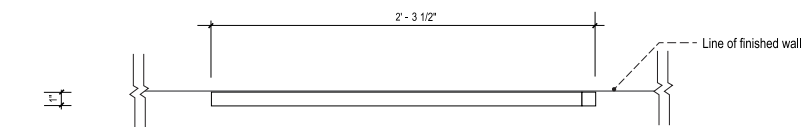

1 TOP VIEW
SCALE: 1 - 1/2" = 1' - 0"

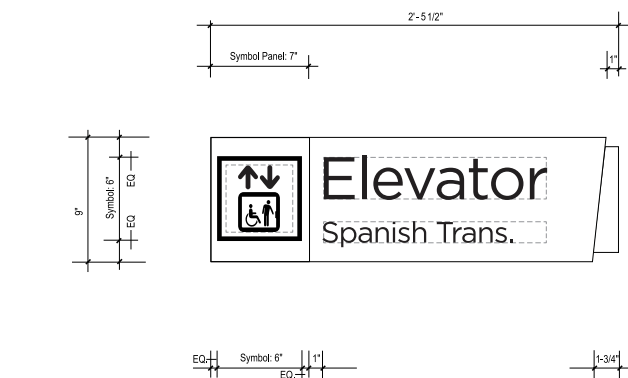

2 FRONT VIEW
SCALE: 1 - 1/2" = 1' - 0"

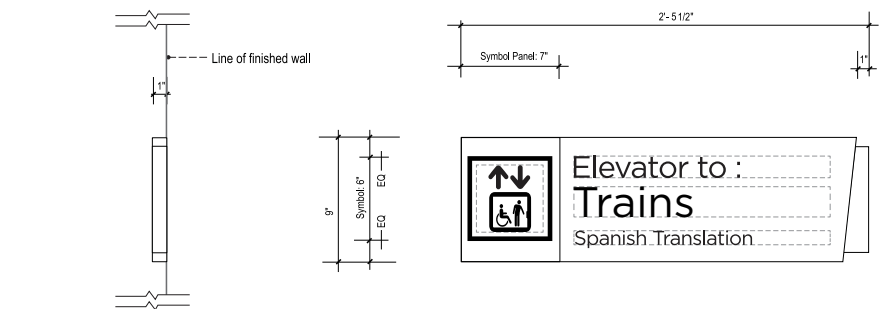

3 SIDE VIEW
SCALE: 1-1/2" = 1' - 0"

4 FRONT VIEW (ALT. LAYOUT)
SCALE: 1 - 1/2" = 1' - 0"

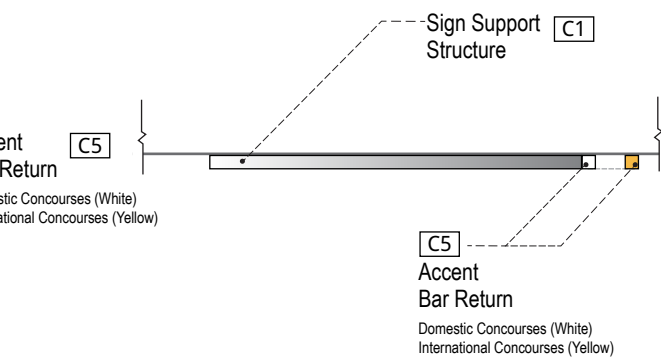

7 TOP VIEW SIGN FINISHES
SCALE: NTS

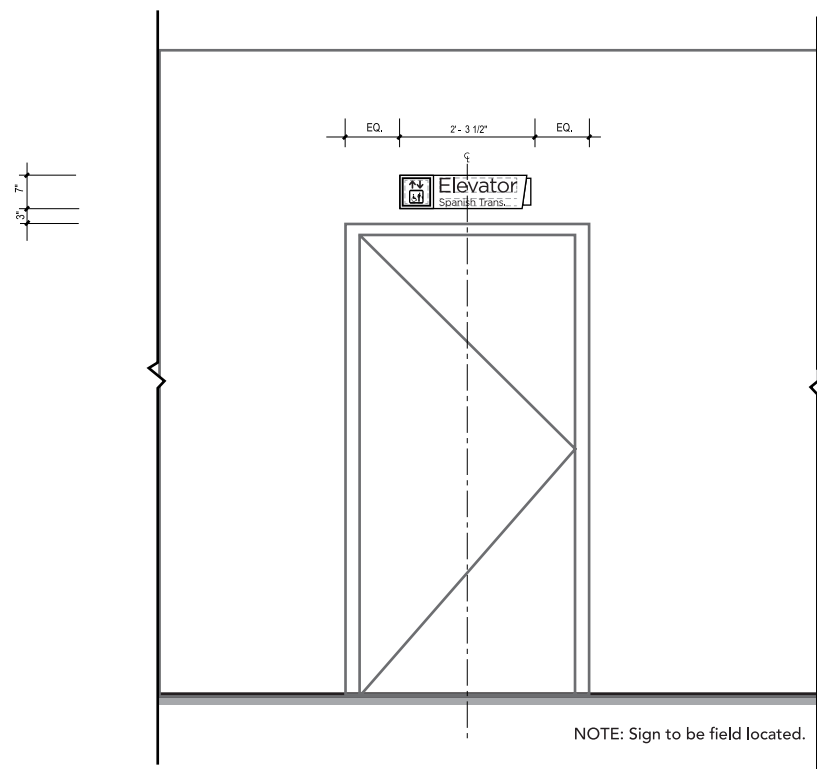

8 ELEVATION
SCALE: 1/2" = 1' - 0"

Identification ST-252

- Descriptions:** Secondary Identification
- Dimensions:** 7" High x 2' - 4" Wide x 1" Deep
- Location:** Concourses. Elevator identification.
- Material:** Seamless fabricated Clear Acrylic.
- Lettering:** 1. English - Gotham Book - 3" Cap height
- Symbology:** Refer to Section 1 - Graphics Standards
- Colors:**
 - C1** Sign Panel - Seamless fabricated .125" clear acrylic with all edges and return sanded to a smooth finish laminated with Satin brushed alluminum
 - C2** Symbol Panel - Black Vinyl
 - C3** Symbol - White Vinyl
 - C4** Messages - English - Black Vinyl
 - C5** Accent Bar - Seamless fabricated .125" clear acrylic with all edges and return sanded to a smooth finish. (Translucent Sign Grade Polycarbonate) corresponding to assigned accent colors for: Domestic Concourses - White Acrylic International Concourses - Pantone 123 (Yellow) - Locations T.B.D.: Assigned by Owner / Owner's Rep.

- Graphics:** N/A
- Mounting:** Wall Mounted
- Illuminations:** None
- Remarks:**

Note:
1. Colors are not interchangeable, and cannot be substituted.

2.0 SIGN TYPE CONCOURSES

#	REVISION	DATE
1	Updated	05/06/16
2	Updated	08/24/17

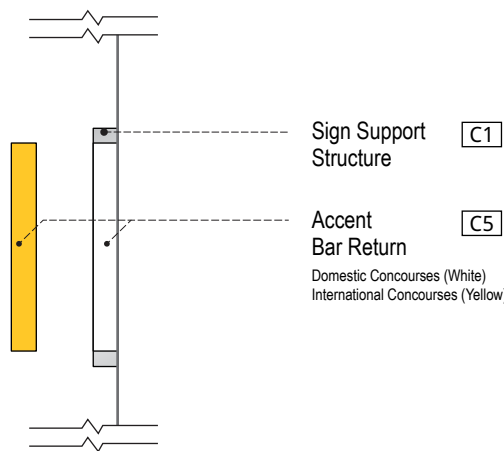

6 SIGN FINISHES
SCALE: NTS

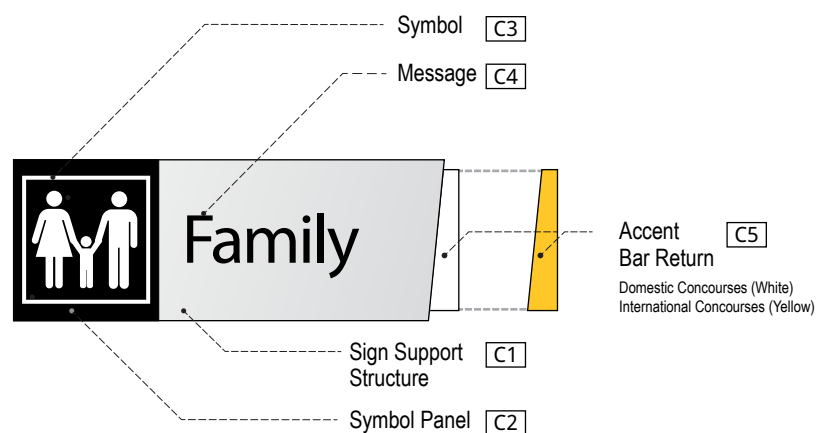

7 SIGN FINISHES
SCALE: NTS

2.4 Sign Type Layouts

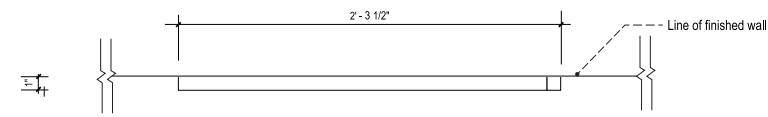

1 TOP VIEW
SCALE: 1 - 1/2" = 1' - 0"

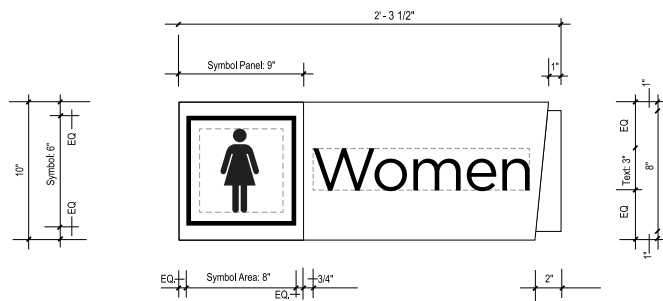

2 FRONT VIEW
SCALE: 1 - 1/2" = 1' - 0"

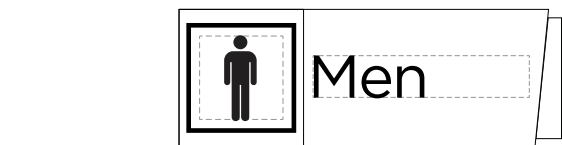

3 FRONT VIEW
SCALE: 1 - 1/2" = 1' - 0"

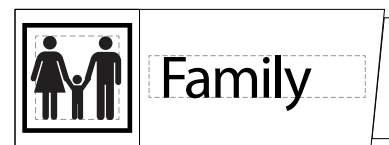

4 SIDE VIEW
SCALE: 1-1/2" = 1' - 0"

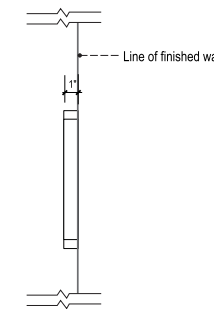

5 FRONT VIEW
SCALE: 1 - 1/2" = 1' - 0"

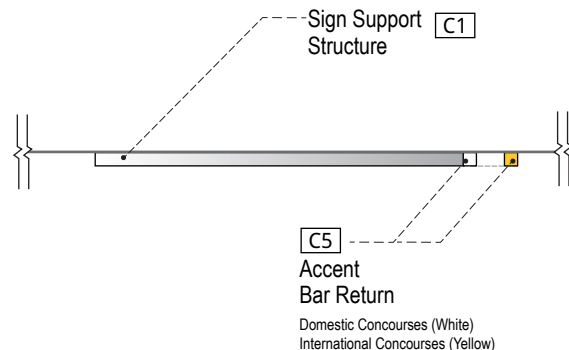

8 TOP VIEW SIGN FINISHES
SCALE: NTS

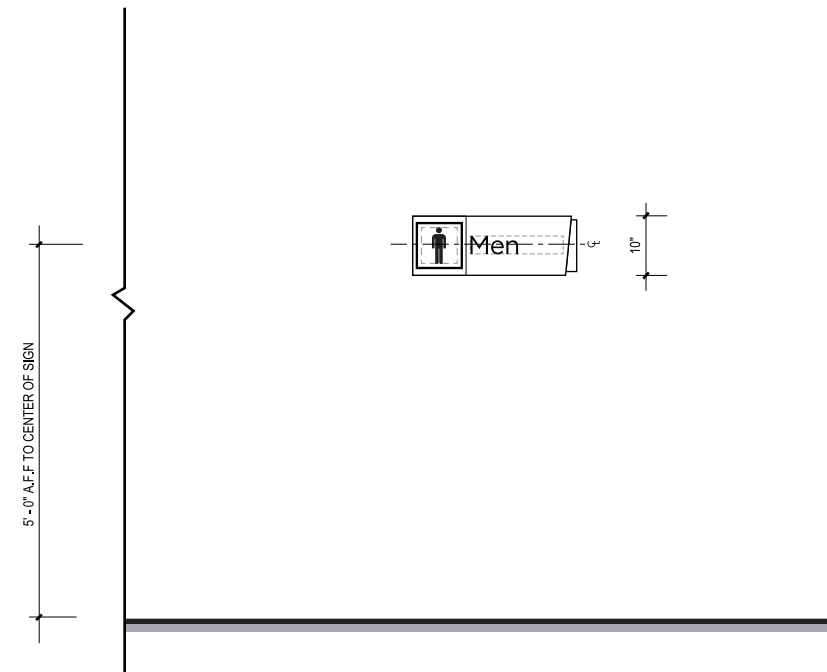

9 ELEVATION
SCALE: 1 - 1/2" = 1' - 0"

Identification ST-254

- Descriptions:** Secondary Identification
- Dimensions:** 10" High x 2' - 4" Wide x 1" Deep
- Location:** Concourses. Restrooms identification.
- Material:** Seamless fabricated Clear Acrylic.
- Lettering:** 1. English - Gotham Book - 3" Cap height
- Symbology:** Refer to Section 1 - Graphics Standards
- Colors:**
- [C1] Sign Panel
- Seamless fabricated .125" clear acrylic with all edges and return sanded to a smooth finish laminated with Satin brushed aluminum
 - [C2] Symbol Panel
- Black Vinyl
 - [C3] Symbol
- White Vinyl
 - [C4] Messages - English
- Black Vinyl
 - [C5] Accent Bar
- Seamless fabricated .125" clear acrylic with all edges and return sanded to a smooth finish. (Translucent Sign Grade Polycarbonate) corresponding to assigned accent colors for:
Domestic Concourses - White Acrylic
International Concourses - Pantone 123 (Yellow) - Locations T.B.D.: Assigned by Owner / Owner's Rep.

- Graphics:** N/A
- Mounting:** Wall Mounted
- Illuminations:** None
- Remarks:** N/A

Note:
1. Colors are not interchangeable, and cannot be substituted.

2.0 SIGN TYPE CONCOURSES

#	REVISION	DATE
1	Updated	05/06/16
2	Updated	08/24/17

2.4 Sign Type Layouts

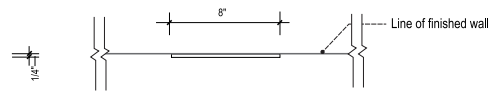

1 TOP VIEW
SCALE: 1 - 1/2" = 1' - 0"

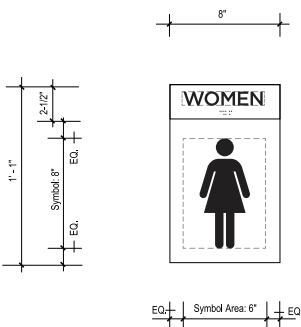

2 FRONT VIEW - WOMEN
SCALE: 1 - 1/2" = 1' - 0"

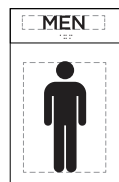

3 FRONT VIEW - MEN
SCALE: 1 - 1/2" = 1' - 0"

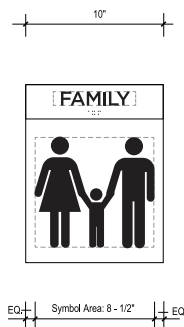

4 FRONT VIEW - FAMILY
SCALE: 1 - 1/2" = 1' - 0"

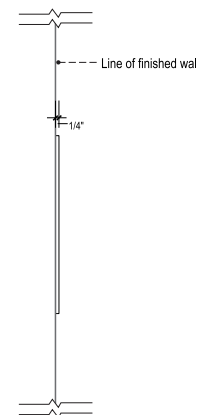

5 SIDE VIEW
SCALE: 1-1/2" = 1' - 0"

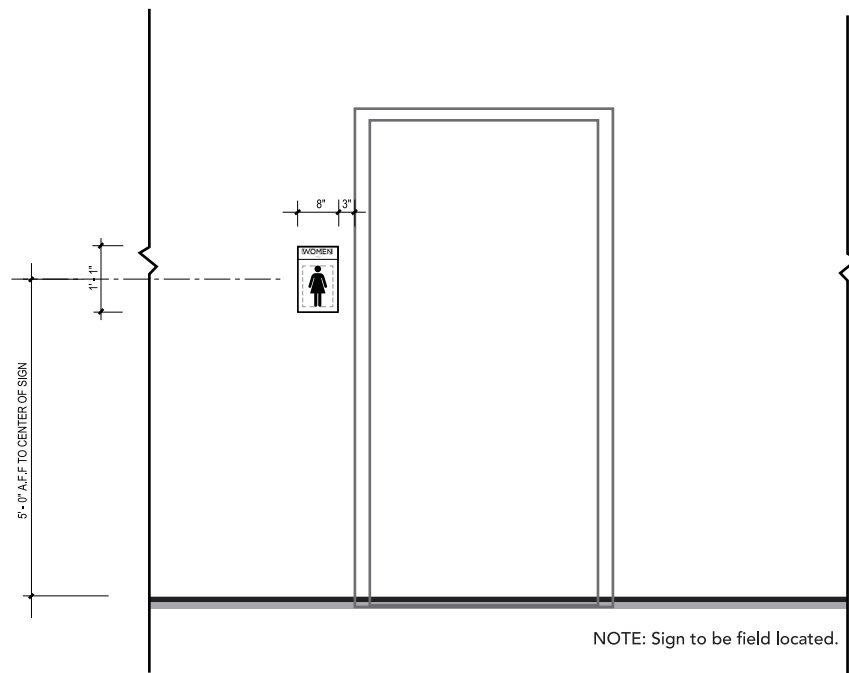
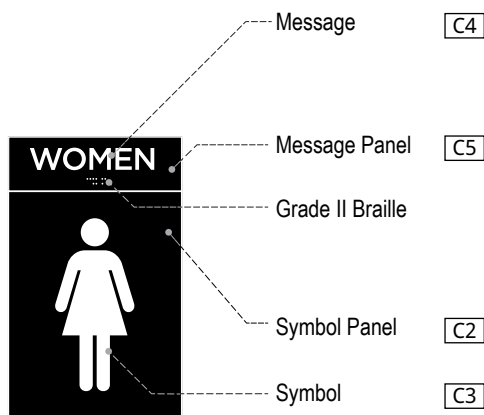

7 ELEVATION
SCALE: 1/2" = 1' - 0"

6 SIGN FINISHES
SCALE: NTS

Identification ST-256

Descriptions: Secondary Identification

Dimensions: 1'- 1" High x 8" Wide x 1/4" Deep

Location: Concourses. Restrooms identification.

Material: Seamless fabricated Clear Acrylic.

Lettering: 1. English - Gotham Book - 1" Cap height

Symbology: Refer to Section 1 - Graphics Standards

Colors:

- C1** • Sign Panel
- Seamless fabricated .125" clear acrylic with all edges and return sanded to a smooth finish laminated with Satin brushed alluminum
- C2** • Symbol Panel
- Non - illuminated Black Vinyl overlay.
- C3** • Symbol
- Non - illuminated Electronically cut out White Vinyl overlay.
- C4** • Messages - Dimensional letters
- Black Vinyl
- C5** • Message Panel
- Seamless fabricated .125" clear acrylic with all edges and return sanded to a smooth finish laminated with Satin brushed alluminum

Graphics: N/A

Mounting: Wall Mounted

Illuminations: None

Remarks: N/A

Note:
1. Colors are not interchangeable, and cannot be substituted.

2.0 SIGN TYPE CONCOURSES

#	REVISION	DATE
1	Updated	05/06/16
2	Updated	08/24/17

2.4 Sign Type Layouts

1 TOP VIEW
SCALE: 1 - 1/2" = 1' - 0"

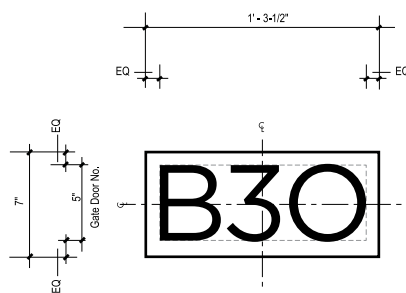

2 FACE LAYOUT
SCALE: 1 - 1/2" = 1' - 0"

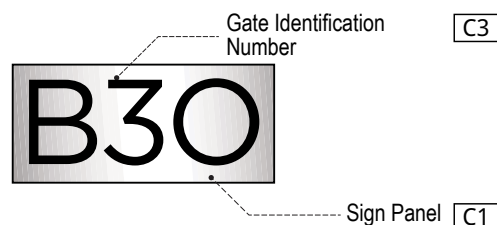
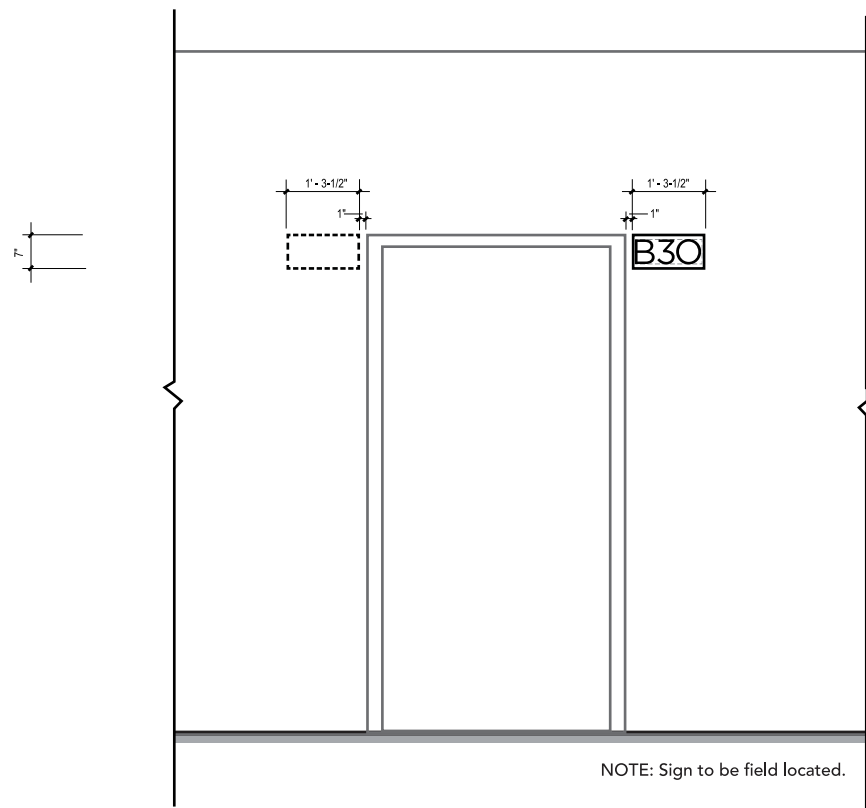

4 SIGN FINISHES
SCALE: 1 - 1/2" = 1' - 0"

5 ELEVATION
SCALE: 1/2" = 1' - 0"

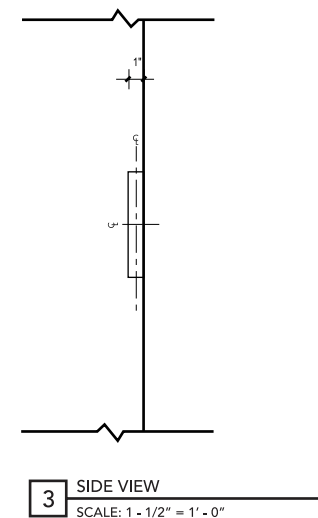

3 SIDE VIEW
SCALE: 1 - 1/2" = 1' - 0"

Identification **ST-258**

- Descriptions:** Secondary Identification
- Dimensions:** 7" High x 1'- 3-1/2" Wide x 1" Deep
- Location:** Concourses. Gate doors identification.
- Material:** Seamless fabricated .125" clear acrylic
- Lettering:** 1. English - Gotham Book - 5" Cap height
- Symbology:** N/A
- Colors:**
 - C1 • Sign Panel
- Seamless fabricated .125" clear acrylic laminated with satin brushed aluminum
 - C2 • Gate Identification Number
- Non - Illuminated electronically cut out Black vinyl
- Graphics:** N/A
- Mounting:** Wall Mounted
- Illuminations:** None
- Remarks:**

Note:
1. Colors are not interchangeable, and cannot be substituted.

2.0 SIGN TYPE CONCOURSES

#	REVISION	DATE
1	Updated	05/06/16
2	Updated	08/24/17

2.4 Sign Type Layouts

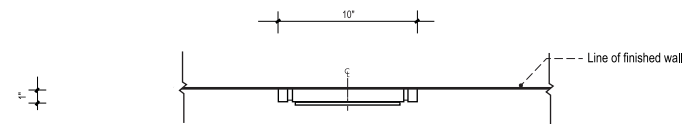

1 TOP VIEW
SCALE: 1 - 1/2" = 1' - 0"

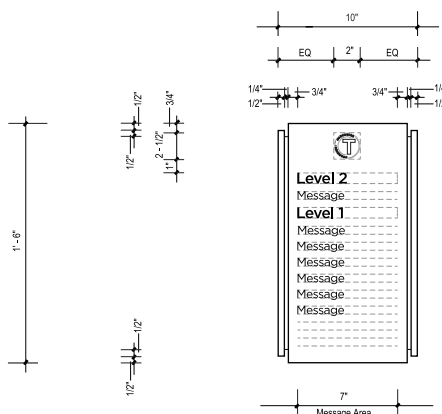

2 FRONT VIEW
SCALE: 1 - 1/2" = 1' - 0"

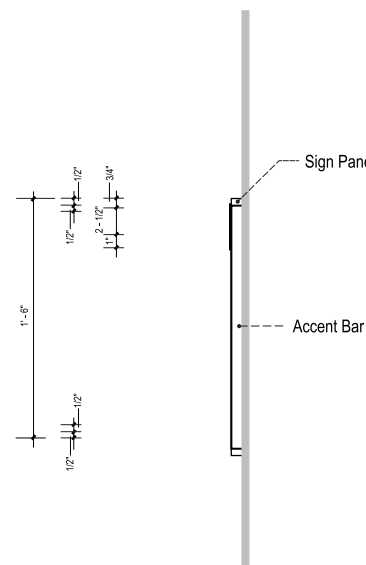

3 SIDE VIEW
SCALE: 1 - 1/2" = 1' - 0"

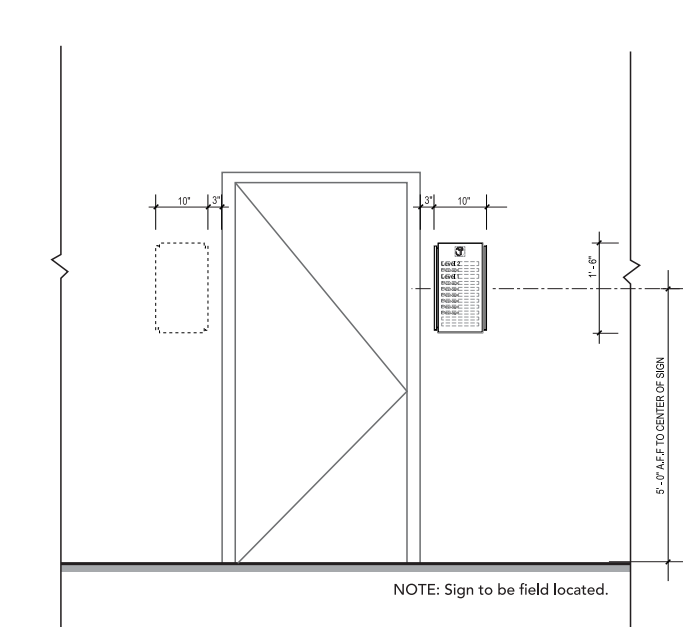
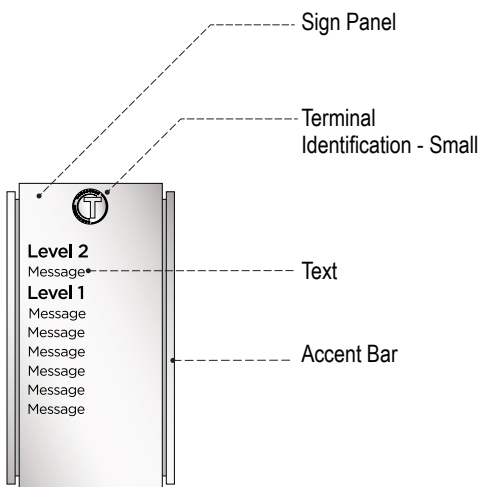

5 ELEVATION - SINGLE ELEVATOR
SCALE: 1/2" = 1' - 0"

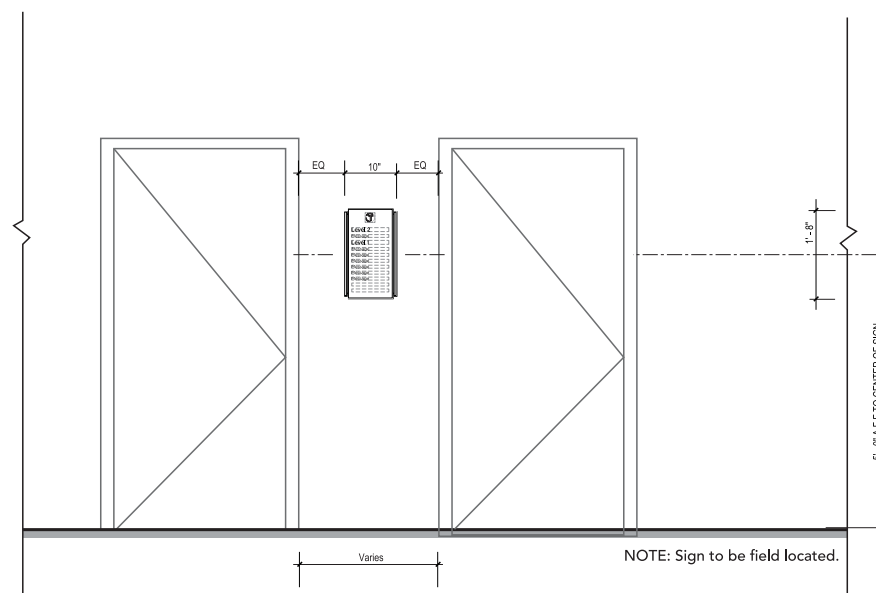

6 ELEVATION - DOUBLE ELEVATORS
SCALE: 1/2" = 1' - 0"

4 SIGN FINISHES
SCALE: 1 - 1/2" = 1' - 0"

Informational ST-260

Descriptions: Primary Informational

Dimensions: 1'- 6" High x 10" Wide x 1" Deep

Location: Concourses. Elevators

Material: Seamless fabricated clear acrylic laminated with satin brushed aluminum.

Lettering: 1. English - Gotham Book - 1/2" Cap height

Symbology: Refer to Section 1 - Graphics Standards

Colors:

- C1** Sign Panel
 - Seamless fabricated .125" clear acrylic with all edges and return sanded to a smooth finish laminated with satin brushed aluminum finish.
- C2** Text
 - Machine cut letters applied on first surface Black vinyl.
- C3** Refer to Section 1 - Graphics Standards
 - Terminal Identification
 - High resolution digital print mounted onto .125" circular satin brushed finish aluminum.

Graphics: N/A

Mounting: Wall Mounted

Illuminations: None

Remarks: N/A

Note:
1. Colors are not interchangeable, and cannot be substituted.



 **Hartsfield-Jackson**
Atlanta International Airport.

Prepared by:  **AIS** |  **VALANCOURT**
INTERNATIONAL, LLC